

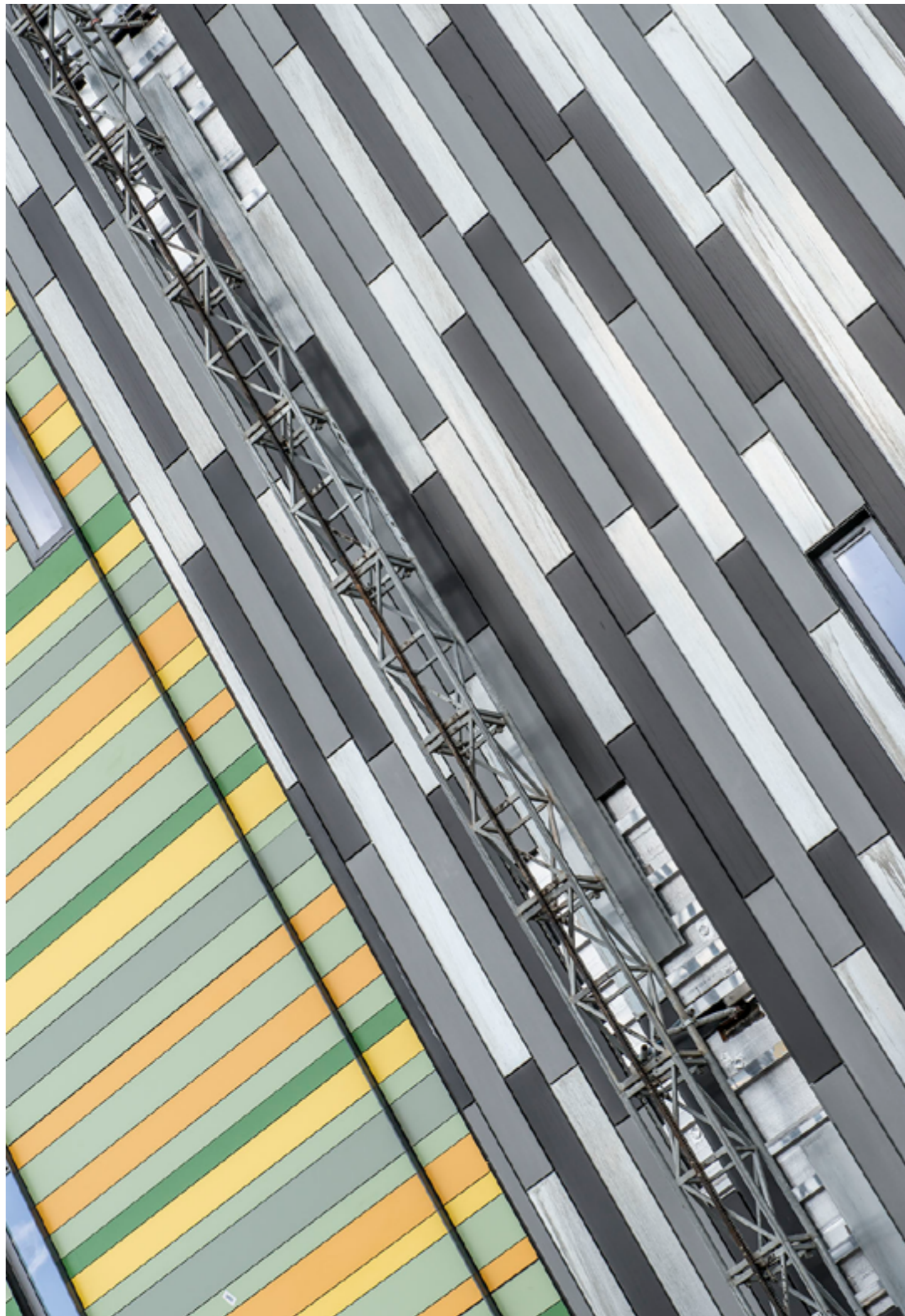

SFS



NVELOPE[®]
Rainscreen
Subframe



The building envelope specialist

We strive for continuous improvement and innovation – always in close collaboration with our customers, colleagues and suppliers. We want to be successful together, improve all the time, see where the technological limits are and drive them forward. SFS creates value with advanced fixing and rainscreen subframe systems for the building envelope. As the leading specialist in this application we offer the highest possible expertise.

Together with our partners we invent new products and services for our shared success.



Contents

Latest additions to the range	7
Introducing SFS ConnectSuite®	9
Project Builder	10
Thermal Builder	11
Drawing Overlay Service	12
Cutting Service	13
Specification	15
Approvals	16
Thermal Solutions	18
Corrosion in Subframe Systems	22
Fire Safety	24
NVELOPE® Systems	26
Cavity Fire Barriers	54
Bracket Options	60
First Level Fixings	68
Profiles (Rails)	74
Second Level Fixings	80
Third Level Fixings	84
Hanger Options	88
Accessories	90

NVELOPE® Rainscreen Subframe-Systems

How to use this brochure

The SFS NVELOPE® Capability brochure has been designed to help you find the right rainscreen solutions quickly. To do this; Identify the right NVELOPE® subframe system for your decorative panel type. Identify the right bracket for the situation. Select the level 1 fixings. Identify the right profile and cutting service options. Select the level 2 fixings. Select the level 3 fixings. Choose any accessories you may need.

Or **make it really simple** and use the Project Builder tool → to do all the hard work.

Latest additions to the range

Cavity Fire Barriers



The new SFS CFB (Cavity Fire Barrier) system and our supporting NVELOPE® Technical Service is created for Designers and Specialist Cladding Contractors who require clear and straight forward approach to aid the selection and supply of Cavity Fire Barriers appropriate for ventilated rainscreen applications.

Thermal Solutions

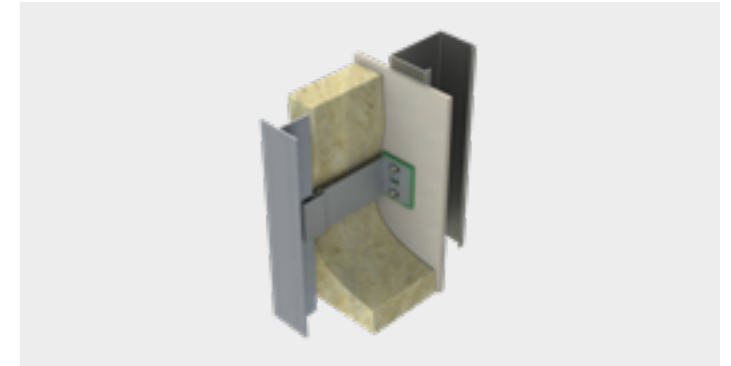

SFS have recently introduced our “Thermal Solutions” range of subframe brackets which help to minimise the effect of cold bridging within the ventilated rainscreen.

Thermal Solutions makes use of 4 bracket ranges which offer the maximum flexibility to balance budget against thermal performance. The ranges are suitable across virtually all of the industry leading NVELOPE® rainscreen subframe systems.

Thermal Solutions also introduces our new non-compressible Thermal Pad which eliminates the effects of thermal degradation during installation thus helping to bridge the performance gap between design and installation.

Additional Support

Introducing SFS ConnectSuite®

**Designed to support you through the
life-cycle of designing a project.**

The right solution or product for your needs. These tools are free to use and accessible through our SFS website. For Rainscreen subframe systems, Project Builder and Thermal Builder are particularly useful tools. Check out the following pages to learn more.

- [Project Builder →](#)
- [Thermal Builder →](#)
- [Drawing Overlay Service →](#)
- [Cutting Service →](#)
- [Specification →](#)



Project Builder

Through our SFS ConnectSuite® tools, you can easily find the right solution for your project.

NVELOPE® Project Builder → is a free online service that allows visitors to our portal to submit their rainscreen building project requirements.

We recognise that each rainscreen design can vary. Our innovative calculation tool is approaching ten years since it was launched and remains the industry standard. Thousands of users have benefited, as a result tens of thousands of calculations have been produced for our customers throughout the past decade.

The design requirements for each rainscreen cladding project are often different and depend on factors such as local wind loads, building height, primary substrate being fixed to, selected cladding material and the chosen cladding zone. All our NVELOPE® systems can be engineered to project specific requirements utilising Project Builder.

NVELOPE® technicians and technology then process the enquiry to output a Project Builder PDF document which provides project specific bracket and rail spacings, guide pricing per m² and a prefilled NBS specification document.

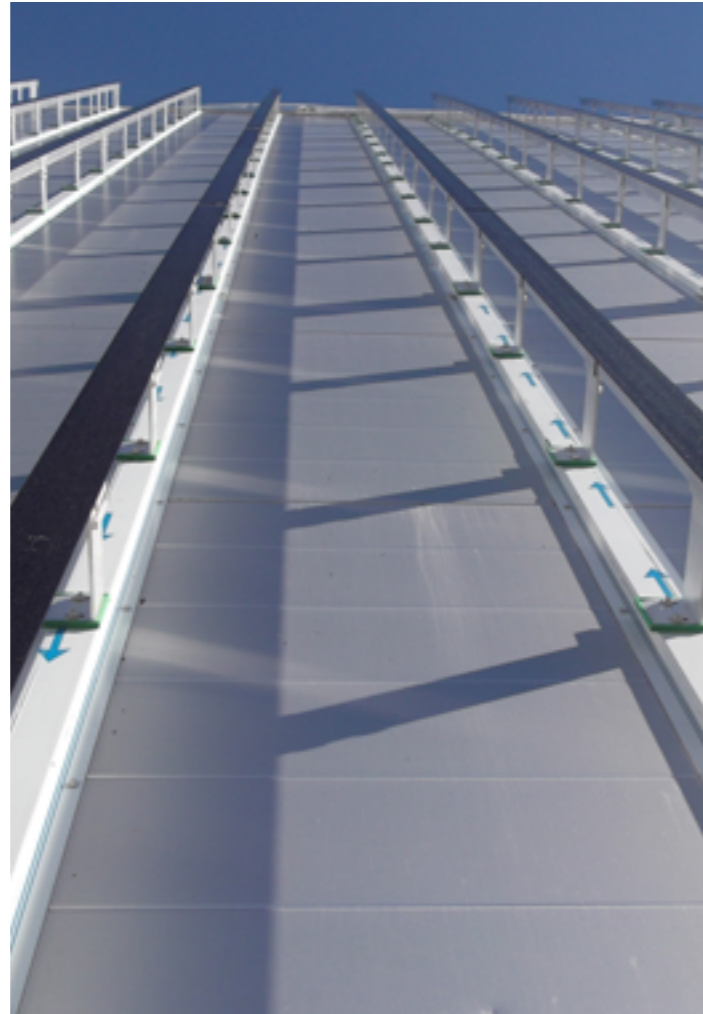

Thermal Builder

To help identify the optimised solution, SFS can take your project details and create specific thermal calculations.

Based on your project's unique wall build-up configuration, our thermal service 3D models each bracket variant to calculate each point loss Chi value. This service is able to dynamically calculate the required insulation depth to achieve your target U-value.

These calculations conform to BS EN:10211 as well as BRE 443 (Convections for U-value calculations) and ensure the full detailed construction is understood rather than a generic scenario which as such, play no reference to the intended design. Our Static calculations determine the parameters for these calculations and thus can also include project specific information such as insulation type and brand.



Thermal calculations made easy

Our free service lets you submit your rainscreen building project requirements online and our technical experts will get back to you within 24 hours, to get your project moving quickly.

Our calculations consider the following criteria

- Thermal bridges via bracket point loss cause increased flow of heat and should be taken into consideration when designing a façade/façade system. Since the fixing of ventilated cladding must go through the thermal insulation into the substrate it cannot be avoided.
- Thermal decoupling of the substructure from the ventilated façade is achieved through thermal separation layers. Our SFS NVELOPE® + Thermal Range can significantly improve bracket point loss and ultimately improve thermal performance.
- The U-value of the plane elements, necessary for the calculation of the overall loss from the building.
- Corrections that need to be made for any thermal bridging, fixings & bracketry. This includes linear heat loss should the rail penetrate the insulation layer.
- The Chi value is the heat loss at (for example) a bracket and is measured as W/mK. Either a default correction is used or a 3D calculation is carried out.

Drawing Overlay Service

SFS are able to provide a Drawing Overlay service for specific projects.

This service correctly positions bracket and rails as calculated by our Project Builder static tool into building drawings as supplied to SFS. As part of this process, SFS are able to “optimise” the lengths of profiles used from standard lengths thus reducing wastage. The profile optimisation feature aligns perfectly with our Profile Cutting service described within the following page. The service also produces a list of required fixings and quantifies accordingly.

SFS Drawing overlays can be utilised for:

- Quoting purposes – the provision of a indicative or sample façade area.
- Final quantification of components – the full drawing overlay can be issued, which are based on the drawings forwarded to us.

SFS Drawing Overlays provide a valuable quantification recommendation which further helps to offer additional assurance that our NVELOPE® systems are economically integrated within a safe and effective design.

To find out how our Technical Team can support you with your design, please contact info-nvelope@sfs.com →.

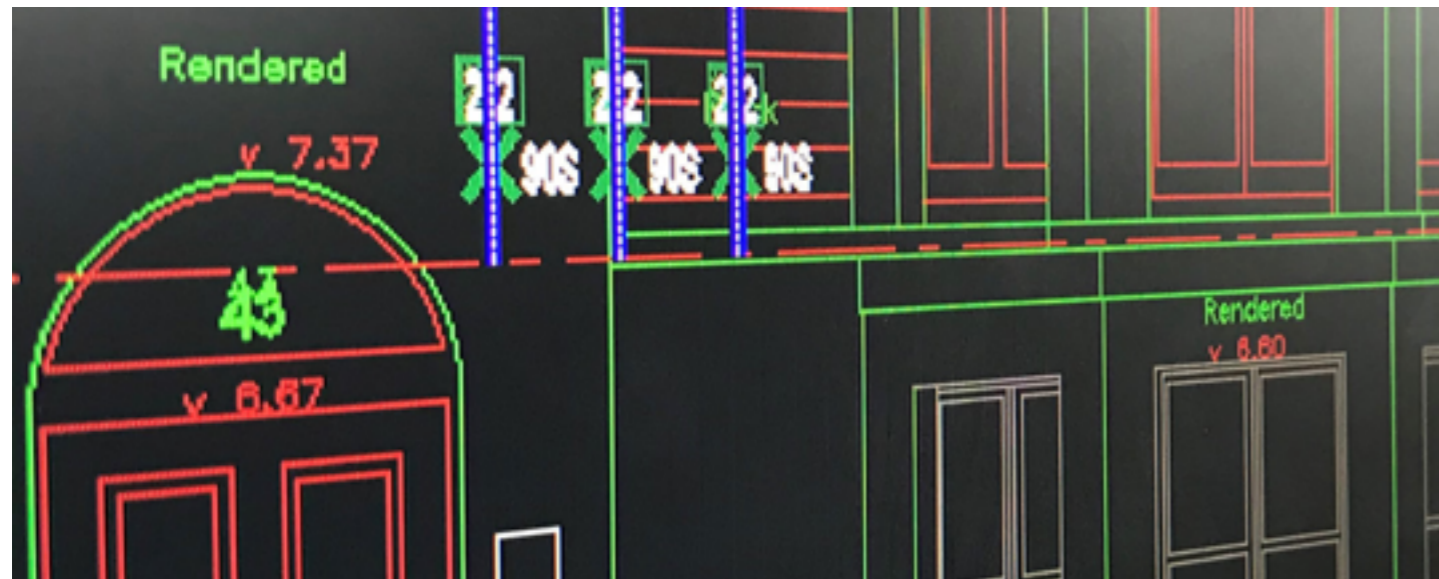

Cutting Service

Reduce waste and install more quickly with our unique optimised profile cutting service.

SFS have recognised a market need to move more activities “off-site” and we recognise the benefits this brings. Our optimised profile cutting service offers additional benefits:

- Optimised material usage – Less waste, lower costs, more environmentally sound
- No disposal issues on site – Lower costs, less space devoted to waste, assures waste is correctly recycled
- Staged Deliveries – Reduces storage, minimises damages and losses
- Health & Safety – Reduced noise and lessened chance of injury
- Optimised Labour – Site teams are focused on installation alone

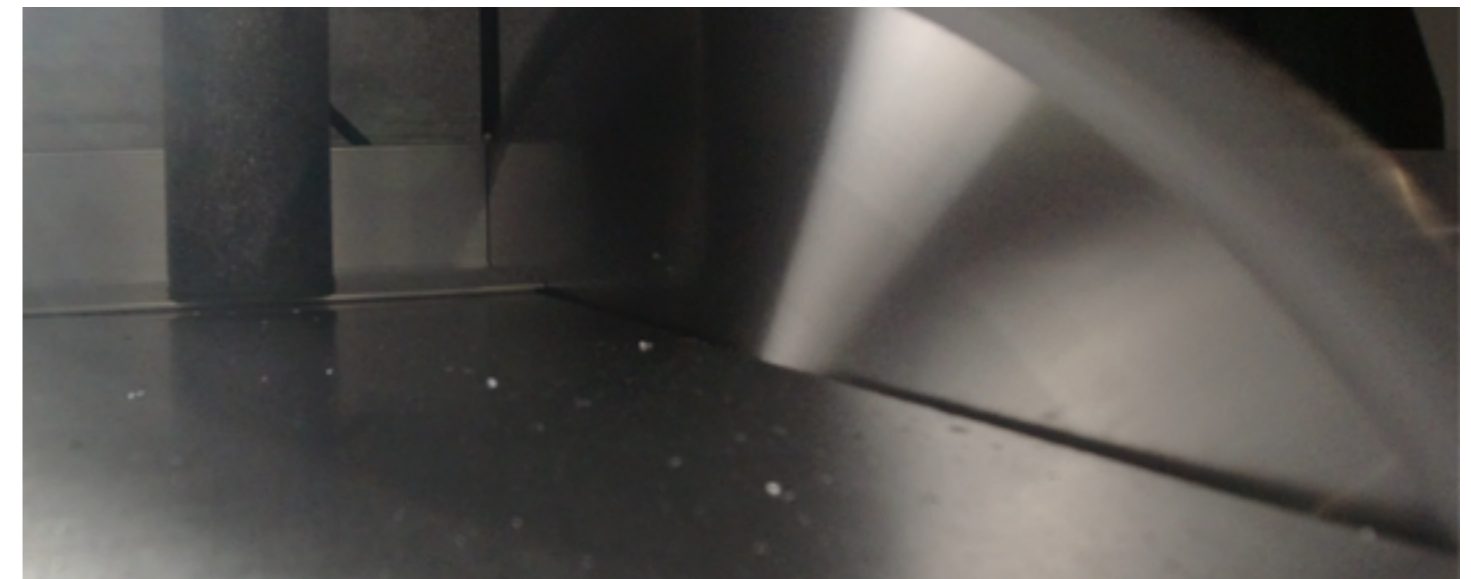

Digital Construction and Specification

The method for digitally designing and constructing our buildings continues to evolve and so our approach at SFS is to be flexible, listen to the needs of our customers and develop tools that assist with the correct use of our systems.

We can offer

- Structured Product Data – allowing relevant attributes to your specific project to be supplied for incorporation into models.
- BIM Models – a range of our systems can be downloaded from the NBS BIM Library → which contain geometry and data.
- 2D and 3D geometry models for use in your system designs.

SFS recognise that the specifier has challenges to overcome which often requires a tailored approach, because of this, we offer a dedicated specification team to support you, ensuring the right solutions are incorporated into your project. Our team understand key issues such as fire and thermal performance, corrosion and air tightness. They can provide guidance on how different systems will perform within the building envelope, ensuring the relevant building standards for your project, are met.

To support, we can offer

- RIBA accredited CPD seminars
- Bespoke system presentations
- Specification writing including the latest NBS Chorus
- Review of project requirements and guidance on our solutions
- Engagement with associated OEM's to provide

For more details please visit uk.sfs.com/specification →.



Approvals

BBA – British Board of Agrément



BBA certification is a mark of excellence based on rigorous National and European standards that validate a construction products formulation, capability and uniqueness.

Earning and maintaining BBA certification demonstrates a commitment to ongoing innovation.

It is recognised, respected and sought after by specifiers, architects and contractors. Assessment reassures all parties that we are an expert in our specialty and we continue to offer the latest advances and best practices, enabling us to deliver the safest, most efficient and highest quality product possible. Our NVELOPE® Rainscreen Subframe System was first awarded a British Board of Agrément certification over ten years ago and was the first system in the UK to gain recognition.

Passive House

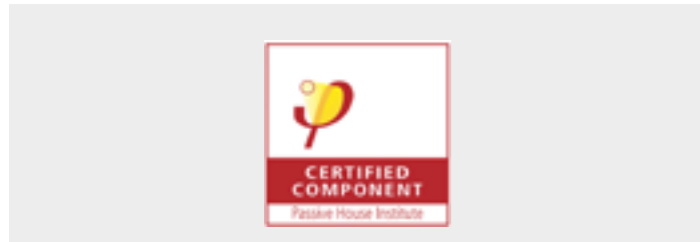

The Passive House Institute (PHI) is an independent research institute that has played an especially crucial role in the development of the passive House concept, an internationally recognised, performance-based, energy standard for the construction industry.

Passive House Certification assures that strict quality requirements of the Passive House Standard have been achieved for buildings and particularly building components.

Our **NVELOPE® NVS Stainless Steel bracket** combined with our unique **Thermal Pad** (NVS + Thermal) has been awarded Passive House component accreditation, falling within the Facade Anchor category. The significant reduction in thermal point loss which may be achieved by utilising our **NVS + Thermal system** is clearly recognised by the PHI.

CE/UKCA



All our UK sourced NVELOPE® Subframe stainless steel and aluminium components are covered by our Declaration of Performance (DoP) meeting the requirement of conformity to EN 1090-1:2009+A1:2011 and the technical requirements according to EN 1090-3 & 1090-2.

The content of our DoP is in accordance with ZA3.1 & ZA3.2 of EN1090-1 and assessed under system 2+. Our systems are CE marked as approved by our European Notified Body partner accordingly. UKCA mark will be mirrored during 2021.





Thermal Solutions

Optimised Thermal Solutions

Excellent thermal performance linked to rainscreen façades is a vital prerequisite if we're to meet our carbon reduction targets.

Our NVELOPE® rainscreen subframe systems are an integral part of rainscreen cladding build-up and their impact on heat loss from the façade, plays a key role. By calculating the U-value (Thermal Transmittance W/m^2k) of a building envelope, it is possible to understand the implication thermal performance has when aiming to meet or exceed current building regulations.

As buildings become better insulated, the importance of the effects cold bridging or thermal point loss can have on the overall thermal performance of a dwelling can be significant. Recent research has shown that thermal bridging can be responsible for up to 30% of a dwelling's heat loss (source BRE).

Subframe systems, including the use of brackets which penetrate the insulation layer, can provide a potential source of cold bridging within a ventilated rainscreen. To achieve the ideal thermal solution for your project, SFS have created an innovative range of Thermal Brackets which can be used across the wide range of NVELOPE® systems.

Thermal bracket ranges which work across most of the NVELOPE® systems

NVELOPE® Thermal Solutions makes use of 4 bracket ranges to ensure maximum flexibility to balance budget against thermal performance and are available across virtually all NVELOPE® systems.

Bridging the performance gap

Utilising our UK patent pending technology, SFS have created a thermal pad which guards against thermal degradation due to compression during installation ensuring no loss in thermal performance. The thermal pad can be universally used with most of our bracket ranges.

NVELOPE® Thermal Solutions Ranges

NVELOPE® VB/HB

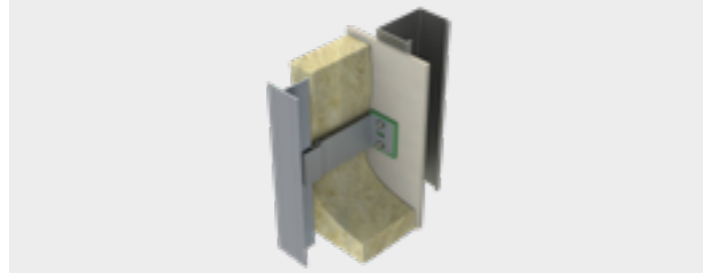

NVELOPE® VB/HB aluminium brackets are supplied with a green plastic “isolator” which offers a degree of thermal benefit. However, its principle function is to eliminate any potential of galvanic corrosion between masonry and aluminium substrates.

NVELOPE® VB/HB + Thermal

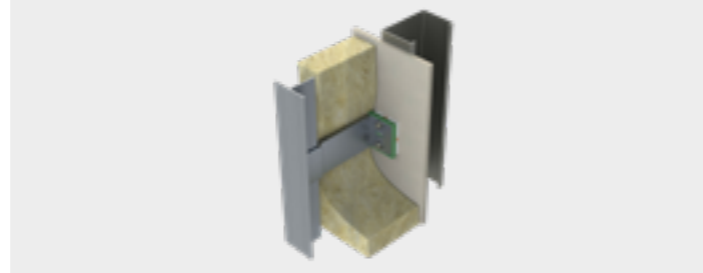

Whilst strong and easy to install, aluminium is very thermally conductive e.g. $>200 \text{ W/m}^2\text{k}$. Therefore, the thermal point loss affects can be significant when aluminium brackets are utilised depending on the combination of various elements within the rainscreen build-up.

The NVELOPE® VB/HB + Thermal range includes an insulation pad at the base of the bracket. This dramatically improves the thermal performance of the rainscreen build-up.

NVELOPE® NVS

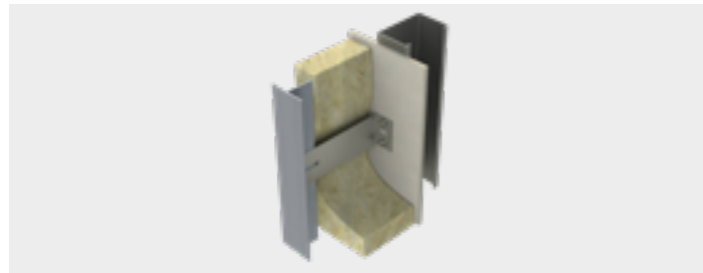

For greater performance SFS have recently introduced a complete range of stainless steel brackets to complement our vertical aluminium ranges. Our stainless steel range is made from superior 316 grade which exhibits far greater resistance to localised corrosion in marine and in contact with atmospheric pollution found in most built up environments.

Stainless steel will demonstrate a much improved increase in thermal performance. Typically stainless steel of approximately 16 W/m.K . This represents a $12 \times$ thermal improvement over and above aluminium. Additionally stainless steel brackets have no requirement to utilise an isolator to alleviate galvanic corrosion.

NVELOPE® NVS + Thermal

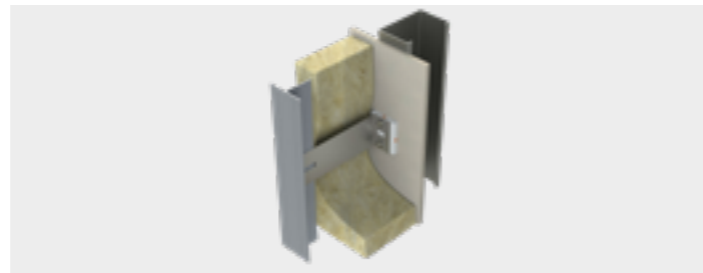

For **optimum thermal performance** NVELOPE® NVS + Thermal is the ideal choice. It offers the combined benefits of high thermal performance with high corrosion resistance for coastal environments.

Where rainscreen build up designs prescribe demanding thermal solutions, this option could offer the ideal high performance answer! Our NVELOPE® NVS Stainless Steel bracket combined with our unique Thermal Pad (NVS + Thermal) has been awarded Passive House component accreditation, falling within the Facade Anchor category.

Optimised Thermal Solutions

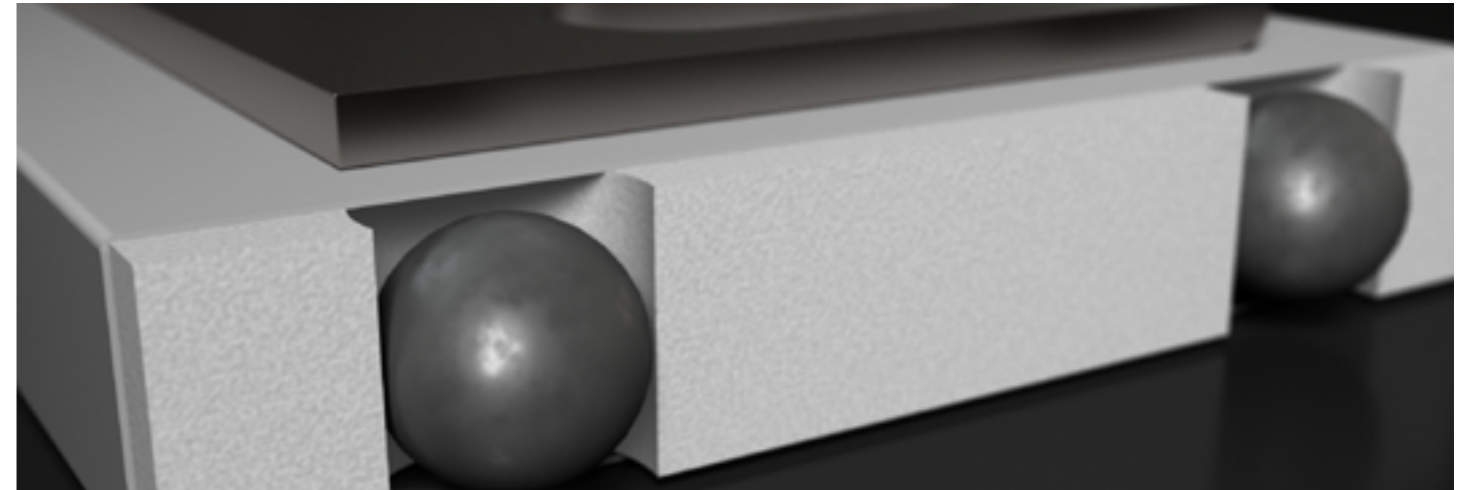

NVELOPE® Thermal Solutions Benefits

- 4 ranges across many NVELOPE® Rainscreen subframe systems.
- Includes aluminium and stainless steel brackets.
- Non-compressible thermal pad reduces thermal performance gap.
- Thermal pad is bonded to the bracket to save on installation time.
- Good to excellent thermal performance.
- Supported by our Project Builder software.

SFS can assist with an understanding of the Thermal effects caused by our components within the rainscreen build-up in respect of heat loss and U-values for a rainscreen project by visiting and using our Thermal Builder, ConnectSuite®, digital tool.

Materials

Aluminium brackets are manufactured from extruded 6005A T6 alloys conforming to EN 573-3 material and EN 755 production standards providing exceptional strength and durability and ideal for good thermal performance. The Stainless Steel brackets utilises the superior 316 grade of material which provides increased resistance to localised corrosion such as in marine or polluted environments. The stainless steel brackets also provide superior thermal performance. The Thermal options incorporate the addition of thermal insulant in the form of a bonded non-compressible insulating pad.

Reduction in the performance gap

Non-compressible insulation pad on the NVELOPE® VB+Thermal, NVELOPE® HB+Thermal and the NVELOPE® NVS + Thermal products reduces the effects from thermal degradation due to compression of the insulating pad. This helps to reduce the performance gap from design to real world installation.

Thermal enhancement

NVELOPE® VB + Thermal, NVELOPE® HB + Thermal and the NVELOPE® NVS + Thermal come with a pre-installed thermal insulated pad. There is no need to assemble these on site which ensures that all brackets are installed correctly with the insulated pad saving time on rework or assembly on site.

Fire Safety

All our NVELOPE® aluminium and stainless steel brackets are defined as Euroclass A1 Non Combustible EC Directive – 94/611/ EC. Our Thermal pad has an A2 Non Combustible Euroclassification.

Thermal Pad

NVELOPE® VB + Thermal, NVELOPE® HB + Thermal and the NVELOPE® NVS + Thermal come with a pre-installed thermal insulated pad. There is no need to assemble these on site which ensures that all brackets are installed correctly with the insulated pad saving time on rework or assembly on site.

Full technical support

As with all NVELOPE® products we offer full technical support.

Warranty

As with all qualifying SFS products we offer an industry leading warranty.



Corrosion in Subframe Systems

Corrosion is an important consideration when using differing metal substrates in combination together.

Galvanic corrosion is an electrochemical process, it occurs as a result of the flow of very small electric currents usually between two dissimilar metals which causes the more anodic of the two metals to corrode. The most common solution to prevent galvanic corrosion is to select materials that are close together in the galvanic series.

The main exception to using stainless steel and aluminium together is the quantity of each material in contact, in the case of the NVELOPE® NVS stainless steel system, the bracket contains the smaller quantity of material.

The cathode area (stainless steel bracket) is very small when compared to the anode area (aluminium rail), this combination will not dramatically decrease the life span.

The table below is taken from "Stainless Steel in Contact with Other Metallic Materials" published by The European Stainless Steel Development Association, 2009.

Corrosion

Recommended material connections/combinatons

Material with a large area	Materials with a small area				
	Carbon steel/Cast iron	Zn galvanised steel	Al	Cu	Stainless steel
Carbon steel/Cast iron	good	poor	poor	good	good
Zn galvanised steel	good	good	good	uncertain	good
Al	uncertain/poor	uncertain	good	uncertain/poor	good
Cu	poor	poor	poor	good	good
Stainless steel	poor	poor	uncertain/poor	good	good

Table from "Stainless Steel in Contact with Other Metallic Materials" by The European Stainless Steel Development Association, 2008



Fire Safety

Fire Safety

Euroclass Standard EN13501-1 provides the reaction to fire classification process for all components and building elements.

The standard defines a reaction to fire as the response of a construction product in contributing by its own decomposition to a fire which it is exposed, under specific conditions. It does not define resistance to fire.

Construction products are classified according to harmonised test methods in Euroclass A1, A2, B, C, D, E and F. Products falling into A1 & A2 classes are classified as non-combustible.

All our NVELOPE® stainless steel and aluminium brackets and profiles are defined as A1 within an EC Directive – 94/611/EC →.

Throughout England, a ban exists on the use of combustible materials used in the external walls of certain high rise buildings and has been implemented by amending Regulation 7 of the building regulations, which deals with materials and workmanship. The amended regulations list materials which are exempt from the limits on combustibility introduced by Regulation 7 (2).

The list of exemptions are described within 7 (3). The list includes Thermal break materials where the inclusion of the materials is necessary to meet the thermal bridging requirements of Part L or Schedule 1 & Fixings.

These exemptions to Regulation 7 may apply to:

- All our aluminium brackets are supplied with “Green” polypropylene isolators which impart improved thermal performance.
- Our Thermal pad, a core component utilised within our Thermal Solutions systems.
- Our fixings and fasteners.

The use of any material exempted by Regulation 7 (3) must also be used in conjunction with the requirements of B4 of Schedule 1 of the Building Regulations 2010.



NVELOPE[®] Systems

Overview

NVELOPE[®] systems are made up from brackets and profiles and are available in various configurations to suit your project or application needs.

Systems

- [Page 28.NV1 →](#)
- [Page 30.NV2 →](#)
- [Page 32.NV3 →](#)
- [Page 34.NV4 →](#)
- [Page 36.NV5 →](#)
- [Page 38.NV6 →](#)
- [Page 40.NV7 →](#)
- [Page 42.NV8 →](#)
- [Page 44.NV9 →](#)
- [Page 46.NV10 →](#)
- [Page 48.NS1 →](#)
- [Page 50.NVF2F →](#)
- [Page 52.NH3 →](#)

NV1

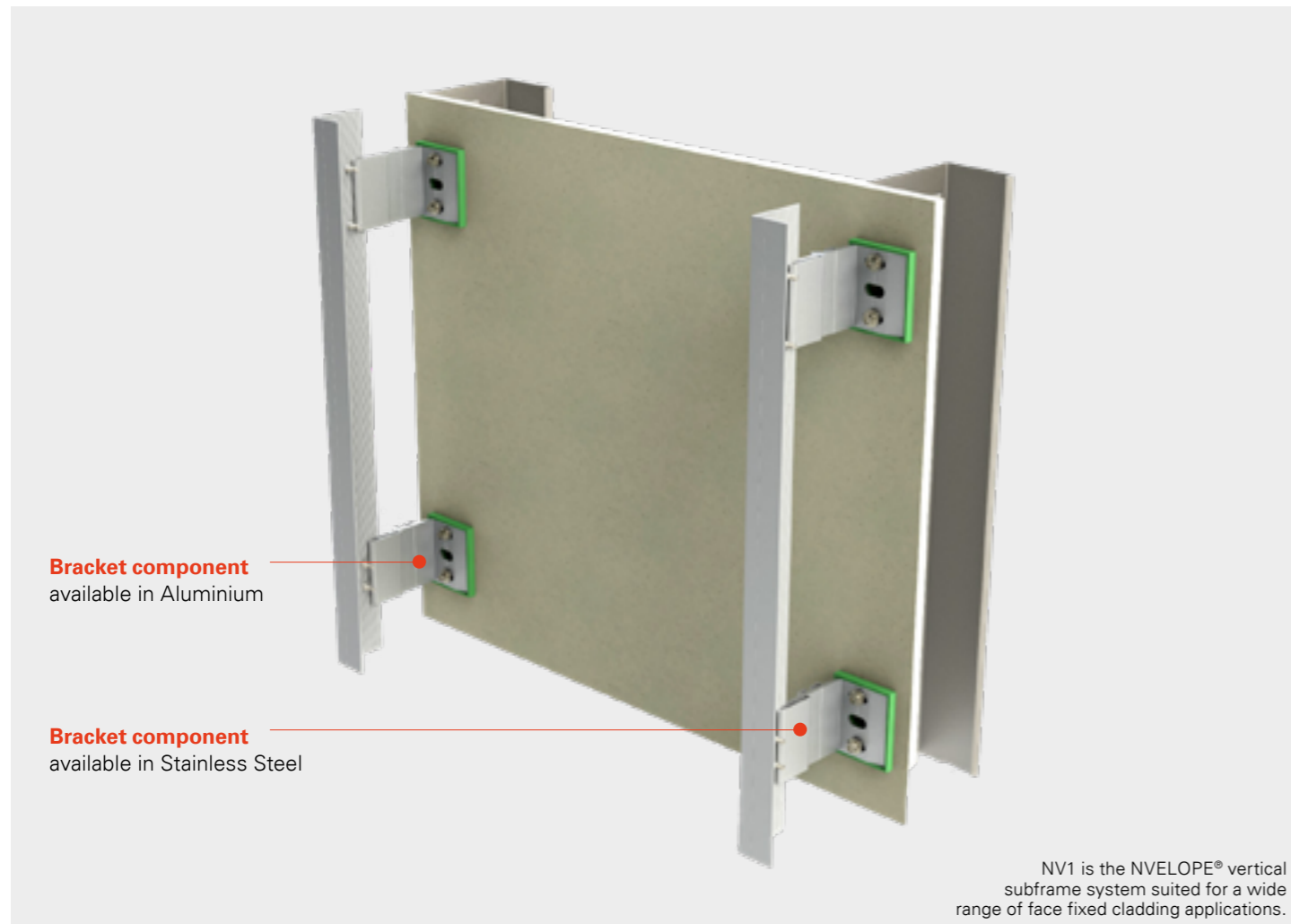

NV1 L and T corner profile

System Type	Isolator Options	Panel Orientations	*BBA	1 st Level Fix	2 nd Level Fix	3 rd Level Fix
Face Fixed	Standard Isolator NVELOPE® Thermal	Vertical & Horizontal	Yes	All fixings	SDA5	Rivet/Panel fixing

*British Board of Agreement

Features & Benefits

- NV1 is the basis of most of our NVELOPE® support systems.
- It forms the backframe for the face fixing of decorative panels and a wide range of other NVELOPE® systems.
- It is compatible with a wide range of NVELOPE® profiles.
- It is suitable for 3rd level fixing and riveting systems.
- Ideal solution for OEM system support.

Downloads

- NV1 Detail drawings** (PDF | 1.07 mb) →
- NV1 Technical Application Guide** (PDF | 1.23 mb) →

NV2

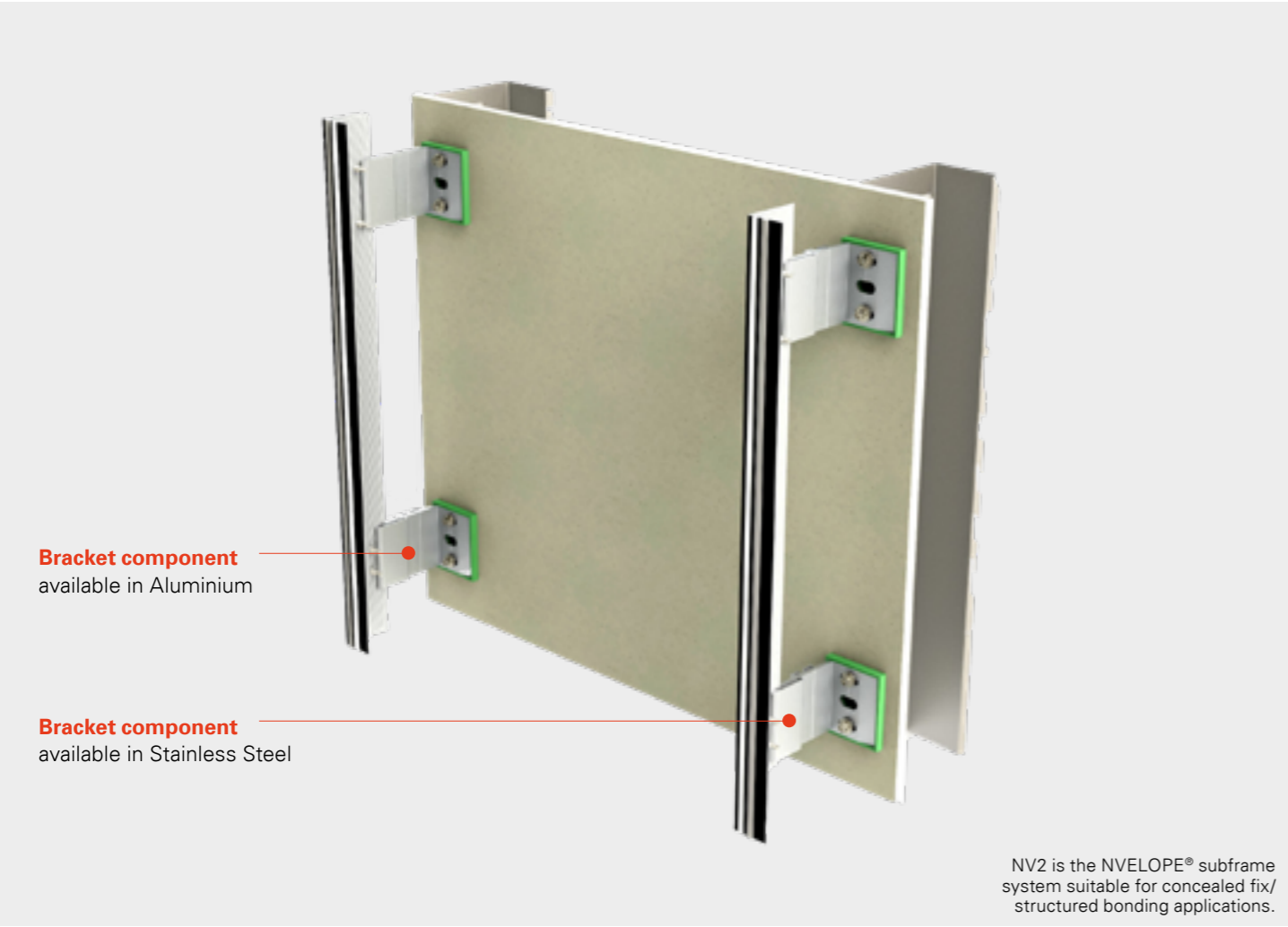

NV2 L and T corner profile

System Type	Isolator Options	Panel Orientations	*BBA	1 st Level Fix	2 nd Level Fix	3 rd Level Fix
Adhesive Concealed Fix**	Standard Isolator NVELOPE® Thermal	Vertical & Horizontal	No	All fixings	SDA5	N/A

*British Board of Agreement/**Seek the relevant adhesive manufacturers advice and recommendation.

Features & Benefits

- NV2 provides a back frame for structural adhesive bonded systems*
- It is compatible with a wide range of NVELOPE® profiles
- Ideal solution for OEM system support.

NV3

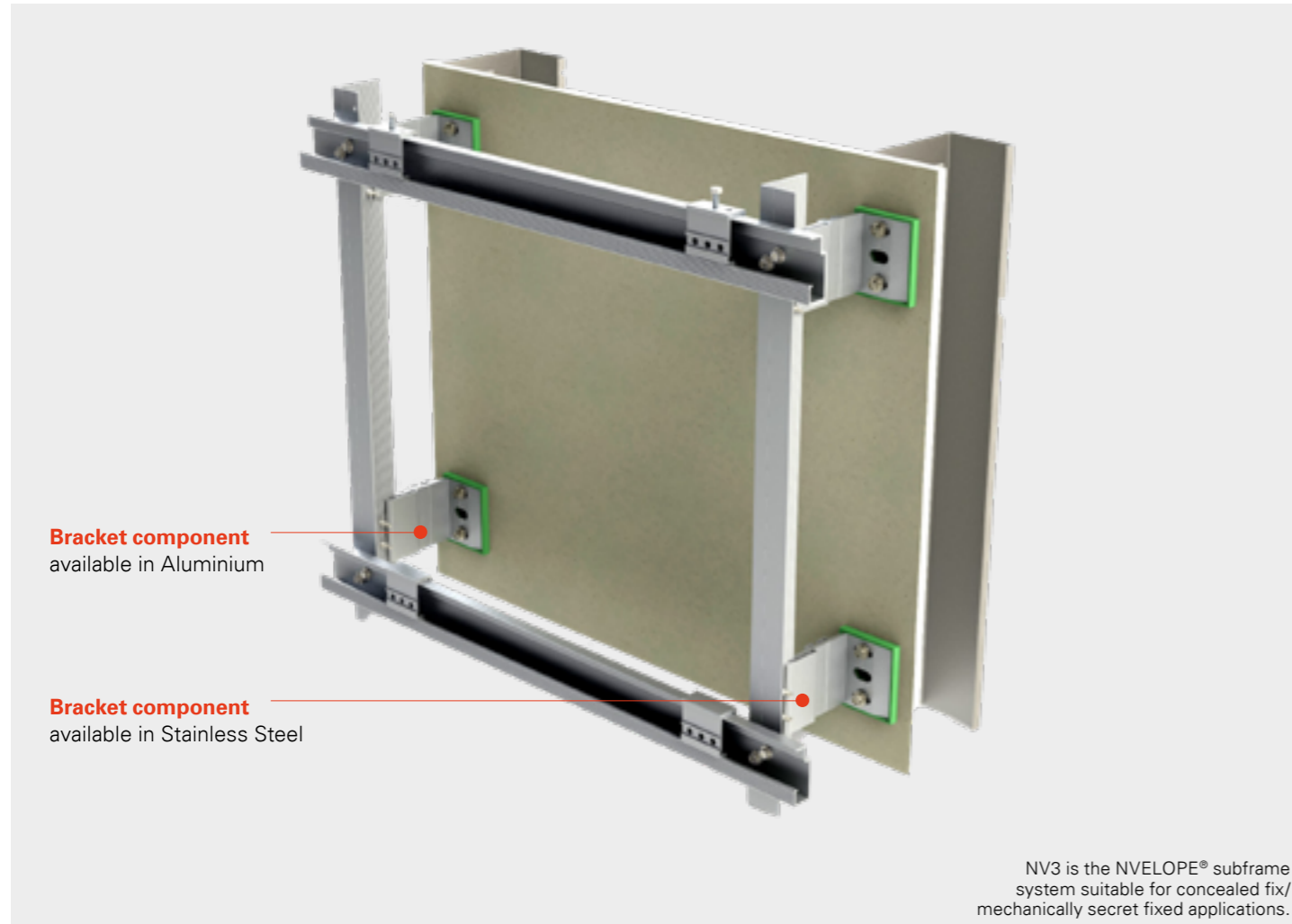

NV3 Only L profile, NV3 profile, NV3 hangers

System Type	Isolator Options	Panel Orientations	*BBA	1 st Level Fix	2 nd Level Fix	3 rd Level Fix
Mechanical	Standard Isolator	Vertical & Horizontal	Yes	All fixings	SDA5	TUF anchor
Concealed Fix	NVELOPE® Thermal				SN3	

*British Board of Agreement

Features & Benefits

- NV3 provides a “hook on” mechanical fix system for concealed panels.
- Fully adjustable hangers.
- Hangers to suit different types of anchor fixing.
- Increased flexibility in panel layout design.
- Can be used in conjunction with our unique TUF secret fixing fastening system.
- Ideal solution for OEM system support.

Downloads

- **NV3 Detail drawings** (PDF | 1.46 mb) →
- **NV3 Technical Application Guide** (PDF | 1.86 mb) →

NV4

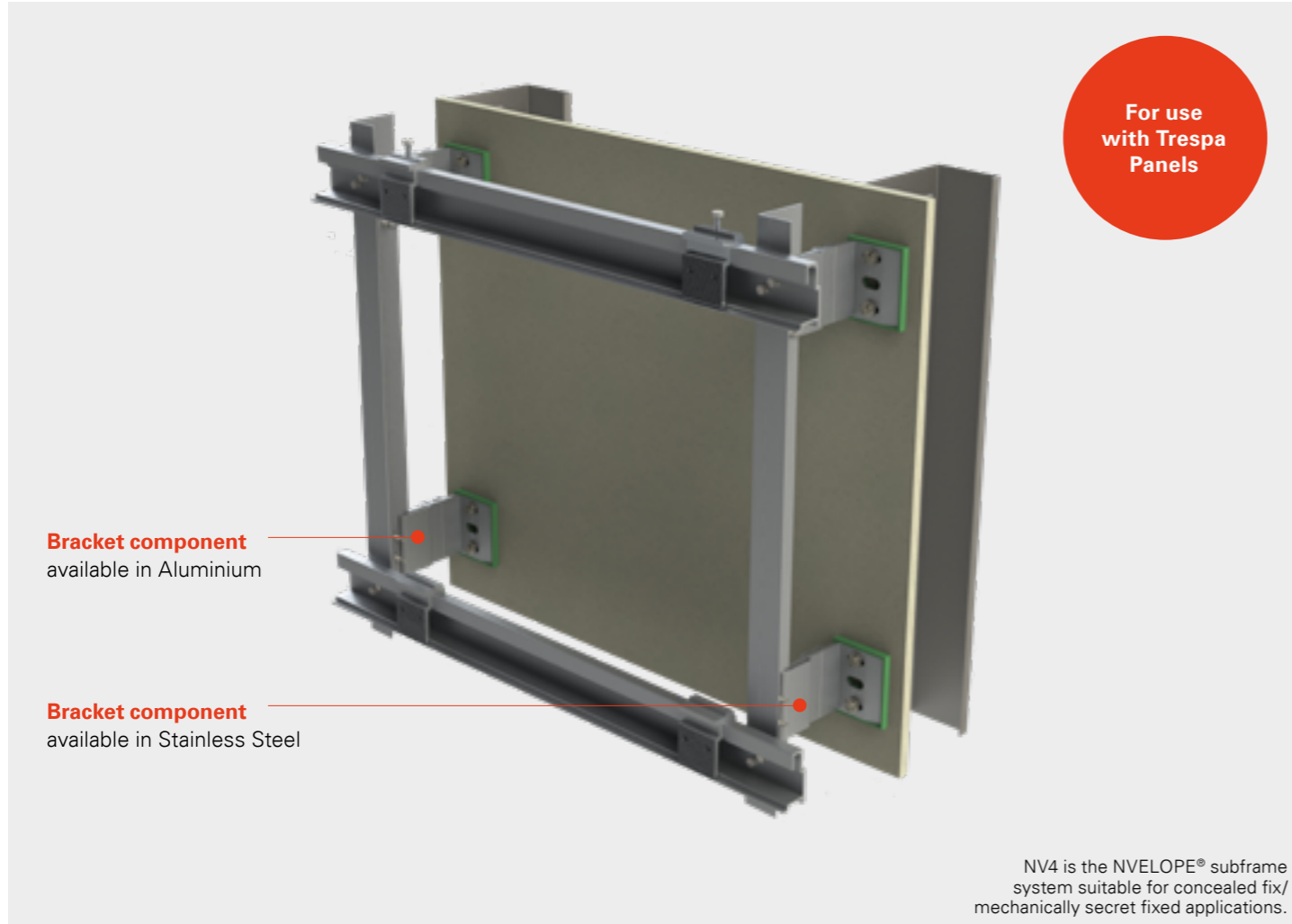

NV4 Only L profile, NV4 profile, NV4 hangers

System Type	Isolator Options	Panel Orientations	*BBA	1 st Level Fix	2 nd Level Fix	3 rd Level Fix
Mechanical	Standard Isolator	Vertical & Horizontal	No	All fixings	SDA5	TUF
Concealed Fix	NVELOPE® Thermal				SN3	PTS

*British Board of Agreement

Features & Benefits

- NV4 provides a “hook on” mechanical fix systems for concealed panels.
- Fully adjustable hangers.
- Hangers to suit different types of anchor fixing.
- Increased flexibility in panel layout design.
- Used in combination with our unique TUF secret fix fastening system.
- Ideal solution for OEM system support.

Downloads

- [NV4 Detail drawings](#) (PDF | 1.35 mb) →
- [NV4 Technical Application Guide](#) (PDF | 1.70 mb) →

NV5

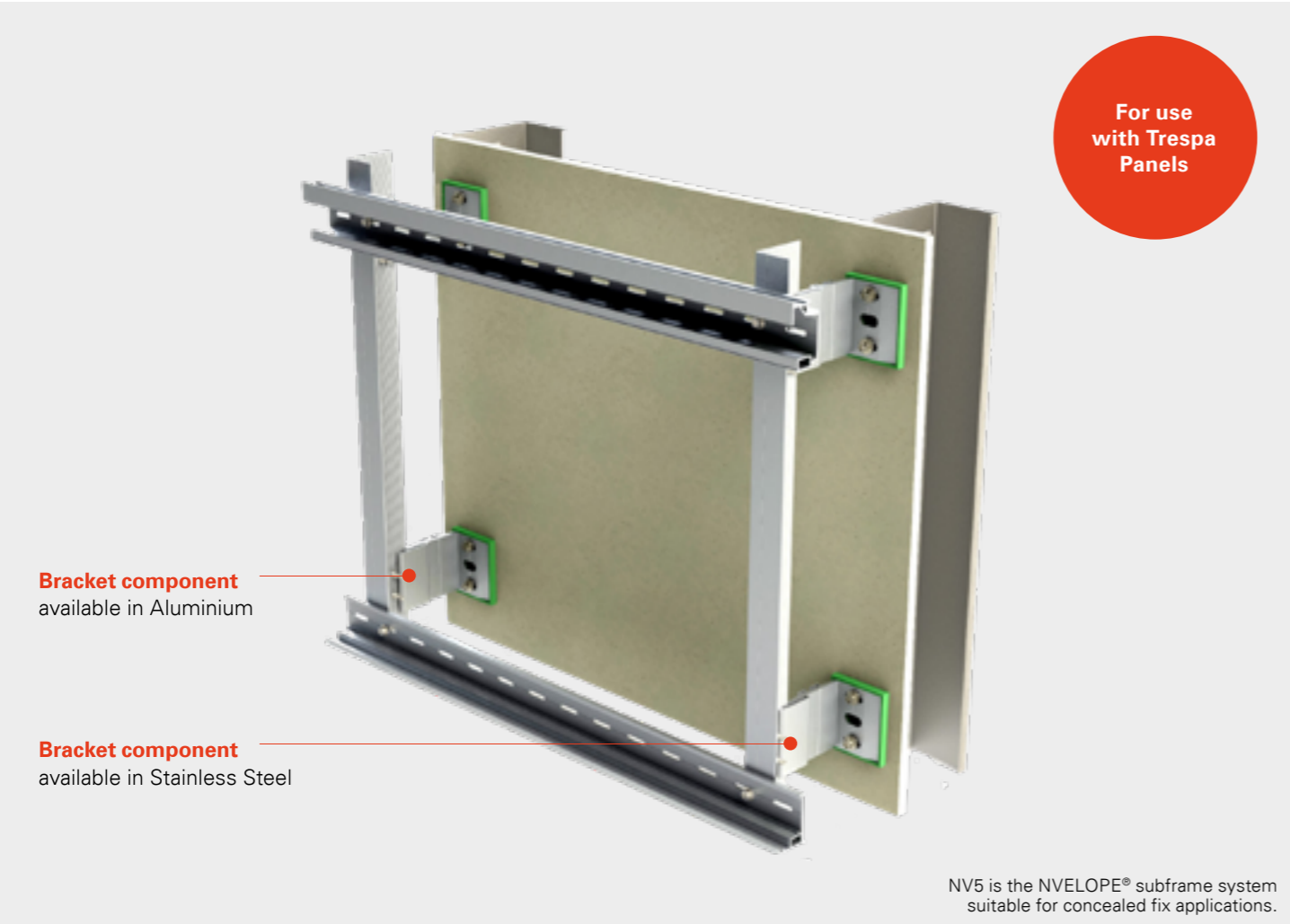

NV5 Only L profile, NV5 Starter Rail, NV5 Mail Rail

System Type	Isolator Options	Panel Orientations	*BBA	1 st Level Fix	2 nd Level Fix	3 rd Level Fix
Mechanical	Standard Isolator	Horizontal	No	All fixings	SDA5	N/A
Concealed Fix	NVELOPE® Thermal					

*British Board of Agreement

Features & Benefits

- NV5 provides a mechanical concealed fix channel system for narrow horizontal panels.
- Can support a range of different panel edge designs.
- Ideal solution for OEM system support.

Downloads

- NV5 Detail drawings** (PDF | 1.54 mb) →
- NV5 Technical Application Guide** (PDF | 2.07 mb) →

NV6

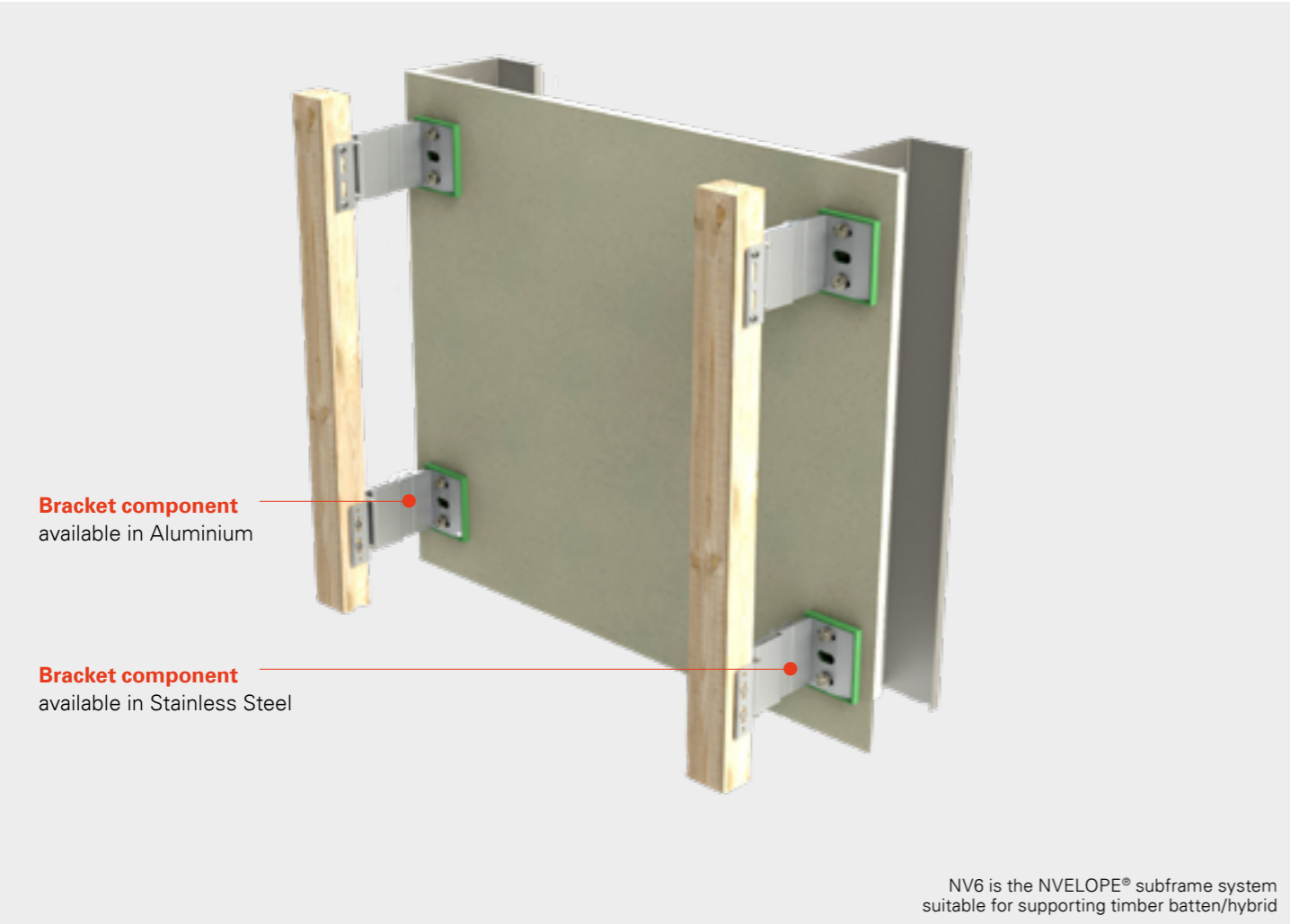

NV6 N/A

System Type	Isolator Options	Panel Orientations	*BBA	1 st Level Fix	2 nd Level Fix	3 rd Level Fix
Timber Face Fixed	Standard Isolator	Vertical &	No	All fixings	SDA5	Panel Fixing
Concealed Fix	NVELOPE® Thermal	Horizontal			SR2	

*British Board of Agreement

Features & Benefits

- NV6 is a hybrid system.
- It creates a timber back frame support system, suitable for face fix panels or concealed fix timber cladding/ weatherboarding systems.
- Range of carrier sizes to suit different size timber.
- Ideal solution for OEM system support.

Downloads

- NV6 Detail Drawings** (PDF | 1.00 mb) →
- NV6 Technical Application Guide** (PDF | 0.86 mb) →

NV7

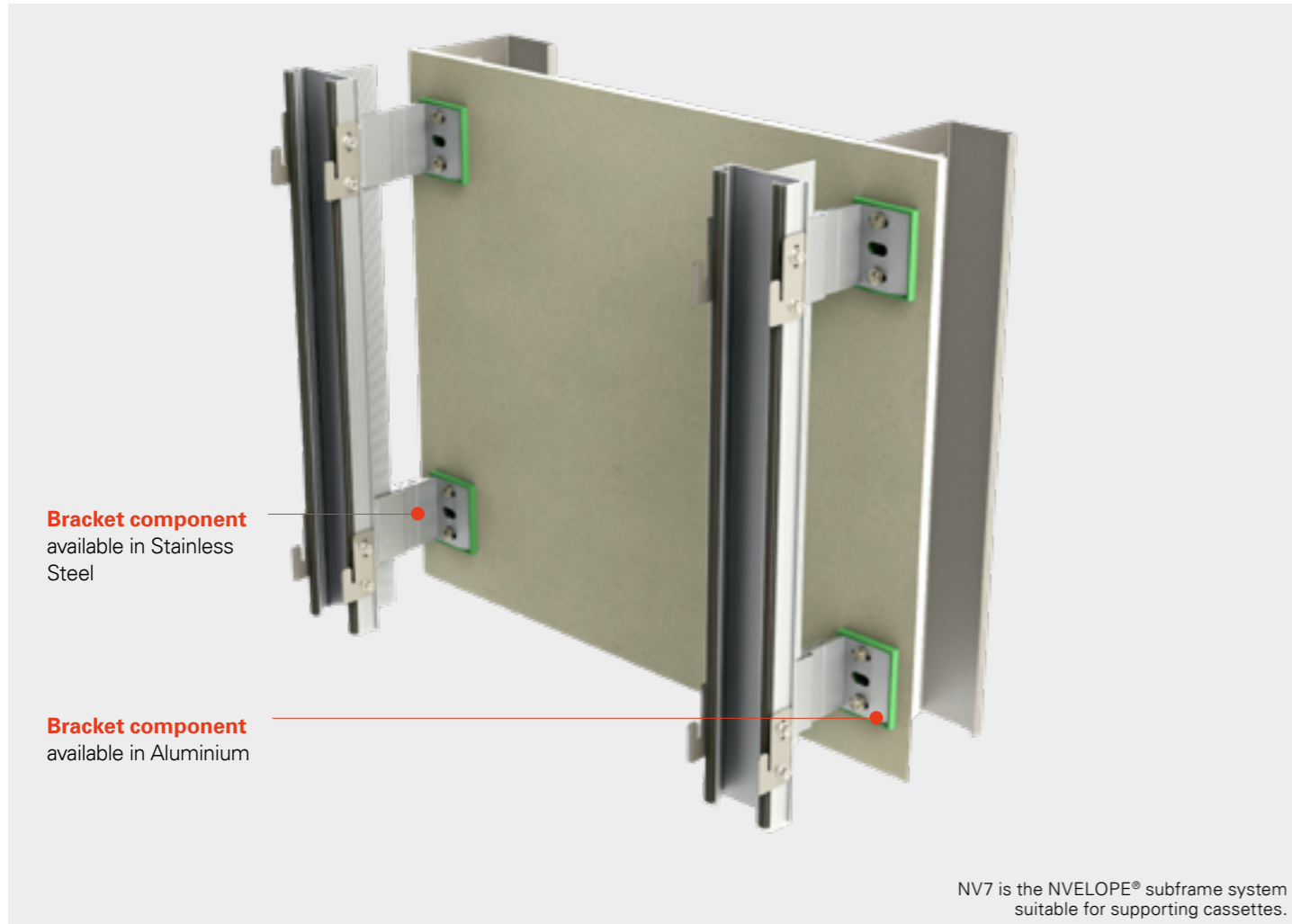

NV7 profile

System Type	Isolator Options	Panel Orientations	*BBA	1 st Level Fix	2 nd Level Fix	3 rd Level Fix
Concealed Fix Cassette	Standard Isolator NVELOPE® Thermal	Vertical & Horizontal	Yes	All fixings	SDA5 SX3	N/A

*British Board of Agreement

Features & Benefits

- NV7 provides a “hook on” mechanical fix system for concealed cassette panels specifically metal panels and ACM.
- Cassette hanger plates fix to the NV7 profile to create a concealed fix.
- Contains panel anti-rattle properties.
- Ideal solution for OEM system support.

Downloads

- [NV7 Detail Drawings](#) (PDF | 1.03 mb) →
- [NV7 Technical Application Guide](#) (PDF | 0.70 mb) →

NV8

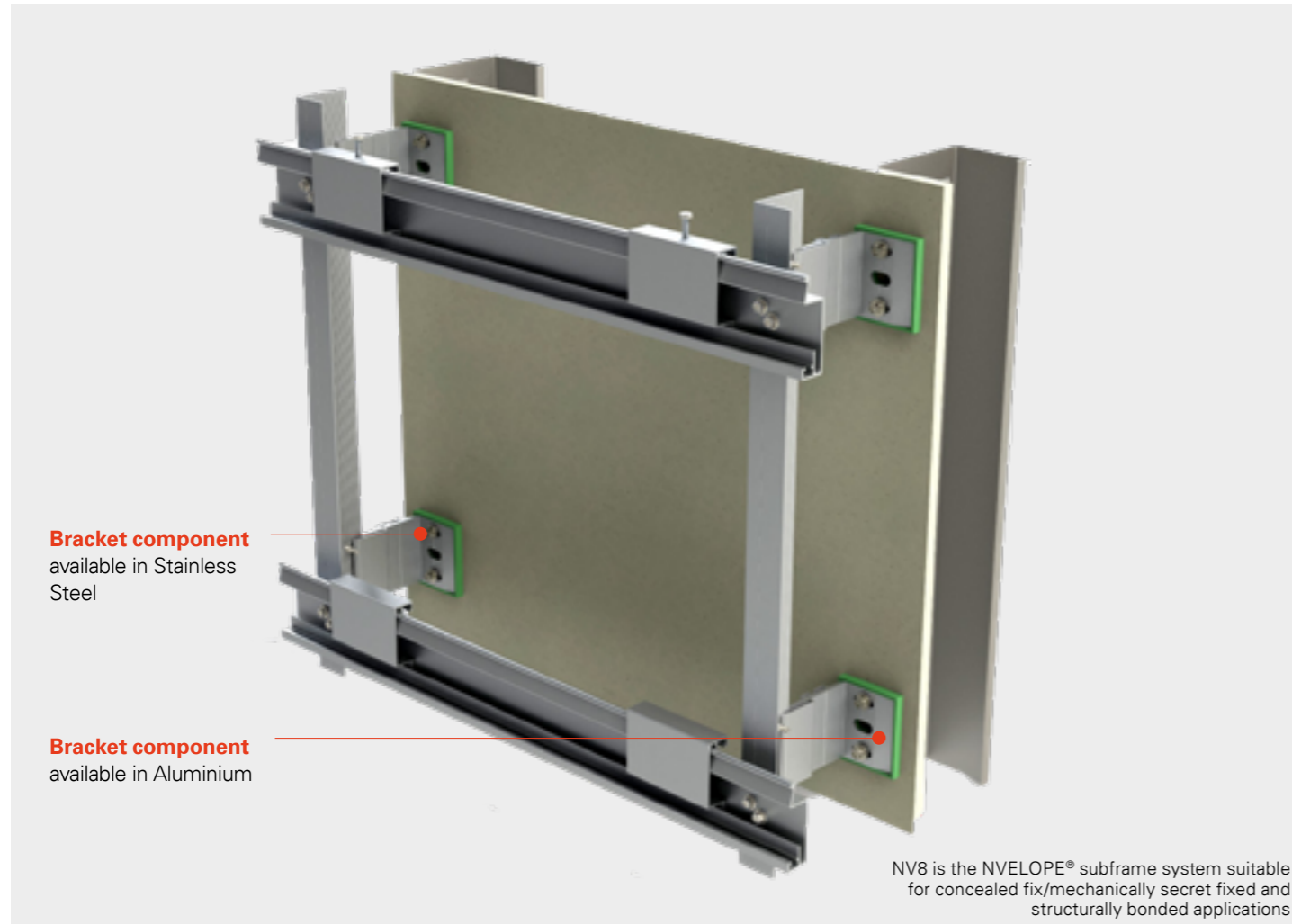

NV8 Only L profile

System Type	Isolator Options	Panel Orientations	*BBA	1 st Level Fix	2 nd Level Fix	3 rd Level
Mechanical/ Adhesive Concealed Fix	Standard Isolator NVELOPE® Thermal	Vertical & Horizontal	No	All fixings	SDA5 SX3	TUF

*British Board of Agreement

Features & Benefits

- NV8 provides a “hook on” mechanical fix system for concealed panels.
- Fully adjustable hanger.
- Hangers designed for structurally bonded adhesive systems or mechanical anchor fixings.
- Increased flexibility in panel layout design.
- Ideal solution for OEM system support.

Downloads

- [NV8 Detail Drawings](#) (PDF | 1.18 mb) →
- [NV8 Technical Application Guide](#) (PDF | 0.85 mb) →

NV9

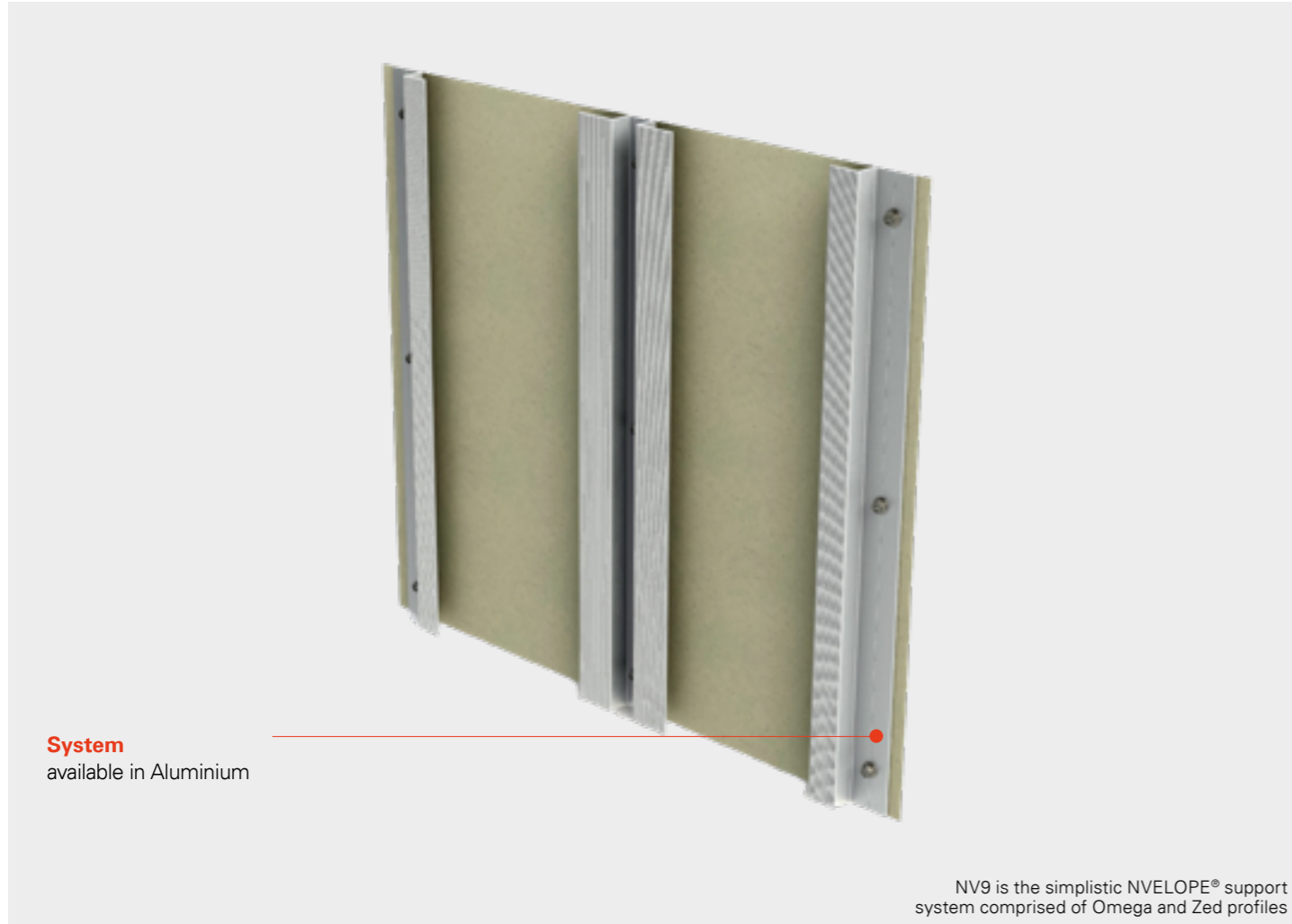

NV9 Omega & Zed profiles

System Type	Isolator Options	Panel Orientations	*BBA	1 st Level Fix	2 nd Level	3 rd Level Fix
Adhesive Fix Face Fixed	No thermal options	Vertical & Horizontal	No	All fixings	N/A	Panel Fixings

*British Board of Agreement

Features & Benefits

- NV9 is for face fixed or adhesive fix panel systems.
- Pre-set profile cladding zones (25mm or 40mm).
- Bracket-less system.
- Ideal solution for OEM system support.

Downloads

NV9 Detail Drawings (PDF | 0.42 mb) →

NV10

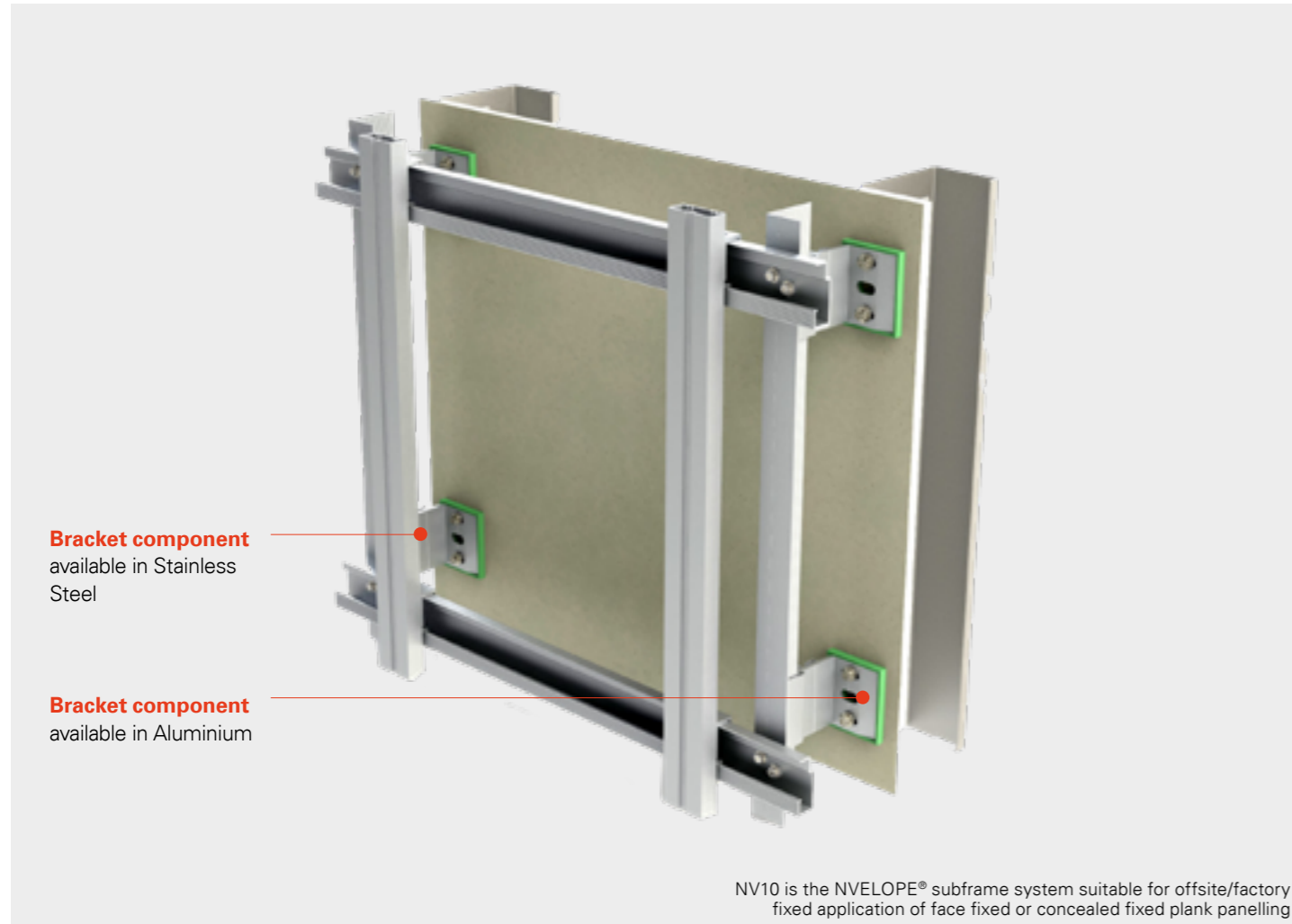

NV10 Only L profiles

System Type	Isolator Options	Panel Orientations	*BBA	1 st Level Fix	2 nd Level Fix	3 rd Level Fix
Mechanical/ Adhesive Concealed Fix	Standard Isolator NVELOPE® Thermal	Vertical & Horizontal	No	All fixings	SDA5 SX3	TUF

*British Board of Agreement

Features & Benefits

- NV10 provides a “hook on” mechanical system for concealed or face fix plank panelling.
- Fully adjustable hangers.
- Install multiple panels at once fixed to the NV10 profile.
- Suited for offsite installation.
- Ideal solution for OEM system support.

Downloads

NV10 Detail Drawings (PDF | 1.40 mb) →

NS1

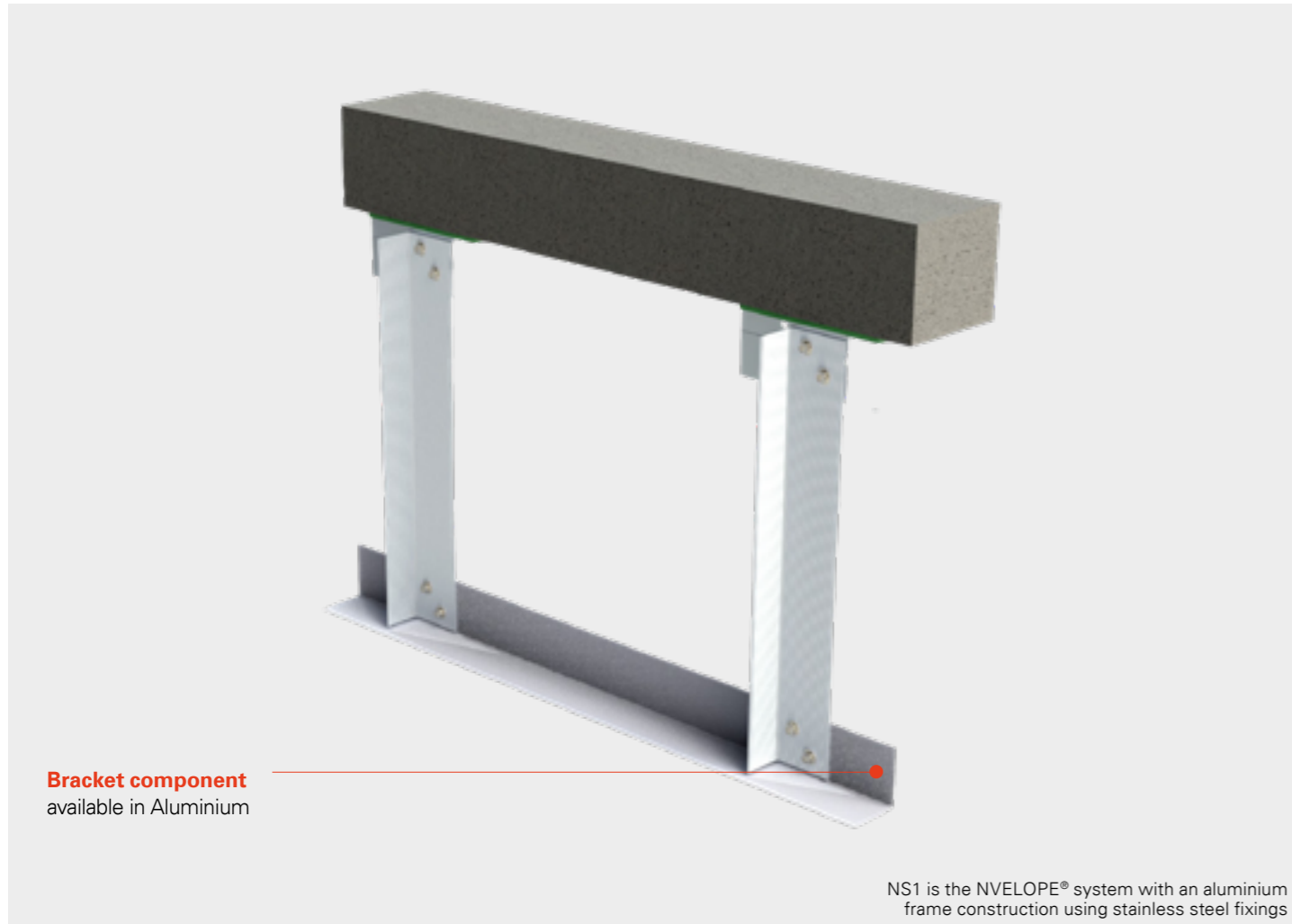

NS1 L and T profiles

System Type	Isolator Options	Panel Orientations	*BBA	1 st Level	2 nd Level Fix	3 rd Level
Mechanical/ Adhesive Concealed Fix	Standard Isolator	Vertical & Horizontal	No	All fixings except SXR	SX3 29 mm	Rivet/Panel Fixing

*British Board of Agreement

Features & Benefits

- NS1 is a Soffit solution for face fix panel systems.
- Soffit drops up to 1 Metre.
- Simple system consisting of NVELOPE® profiles.
- Ideal solution for OEM system support.

Downloads

- **NS1 Detail Drawings** (PDF | 1.04 mb) →
- **NS1 Technical Application Guide** (PDF | 0.73 mb) →

NVF2F



NVF2F Box profile/T Box profile

System Type	Isolator Options	Panel Orientations	*BBA	1 st Level Fix	2 nd Level Fix	3 rd Level Fix
Mechanical/Adhesive Concealed Fix	Standard Isolator	Vertical & Horizontal	Yes	Multi-Monti	M8 Bolt Kit	Rivet/Panel fixing

*British Board of Agreement

Features & Benefits

- The NVF2F system is designed to span across floor levels.
- It consists of aluminium box profiles and dual leg brackets.
- NVF2F can also support NVELOPE® concealed fix systems.
- Can be used where it is not possible to fix brackets between floor levels.
- Ideal solution for OEM system support.

Downloads

- NVF2F Product Information** (PDF | 0.86 mb) →
- NVF2F Technical Application Guide** (PDF | 0.39 mb) →

NH3

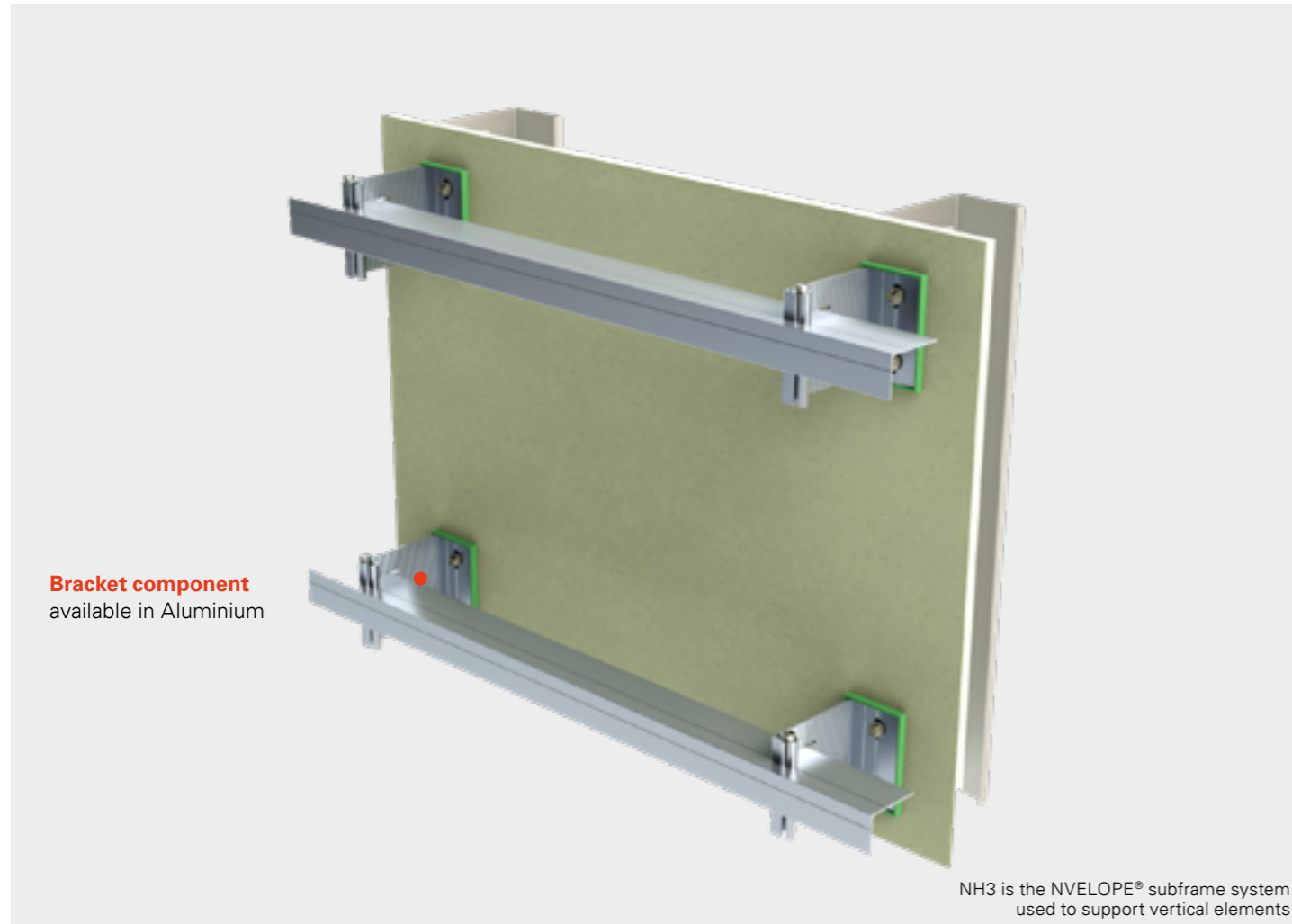

NH3 L Profile

System Type	Isolator Options	Panel Orientations	*BBA	1 st Level Fix	2 nd Level Fix	3 rd Level Fix
Mechanical/Adhesive Concealed Fix	Standard Isolator NVELOPE® Thermal	Vertical	Yes	All fixings	SDA5 45 mm	Rivet/Panel fixing

*British Board of Agreement

Features & Benefits

- The NH3 system provides a horizontal backframe
- Provides a solution for vertically aligned face fix panel systems
- A unique bracket design for horizontal applications
- The NH3 bracket matches the NVELOPE® range of bracket sizes
- Ideal solution for OEM system support.

Downloads

- [NH3 Product Information](#) (PDF | 2.51 mb) →
- [NH3 Detail Drawings](#) (PDF | 2.15 mb) →
- [NH3 Technical Application Guide](#) (PDF | 2.93 mb) →

Cavity Fire Barriers

Passive Fire Protection

The SFS NVELOPE® CFB system has been created for Designers and Specialist Cladding Contractors who demand a clear and straightforward approach to aid the selection and supply of subframe cavity fire barriers.

The requirement to prevent fire breaking into and spreading within the cavity of a rainscreen build-up has gained a high degree of traction in the UK and further afield in certain international regions. The Centre for Window and Cladding Technology (CWCT) describes a rainscreen cladding system as “a wall comprising of an outer skin of panels and an airtight insulated backing wall separated by a ventilated cavity or airgap”.

The basic principle of a ventilated rainscreen system allows any penetrating rain or moisture to “drain” or evaporate and vent back to the outside. Further the effects of pressure equalisation allow the movement of air between the inside and outside so that rain is not driven through into the building structure. These principles rely on free movement of air throughout the cavity or air gap.

During a fire event, however, this freedom of movement could act as a chimney and draw smoke and fire along the cavity. That’s where Cavity Fire Barriers come into effect. Passive cavity fire barriers are an accepted method to support the achievement of fire safety requirements. These functional requirements are defined within UK Building Regulations and further practical guidance is described within ADB.

For more information on our Cavity Fire Barriers or to submit your requirements, complete our brief questionnaire →.

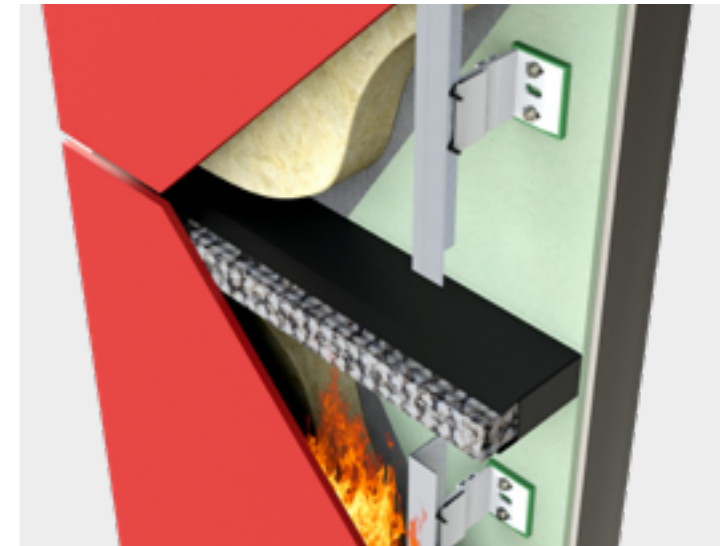

Strategies to remediate at risk buildings are latterly considering passive fire control, including cavity fire breaks, in addition to the façade panel and insulation. Cavities in the construction of a building provide a ready route for the spread of smoke and flame, which can present a greater danger as any spread is concealed. To reduce the potential for fire spread, cavity barriers should be provided for both of the following:

- To divide cavities
- To close the edges of cavities

Cavity barriers should be provided at all of the following locations:

- At the edges of cavities, including around openings (such as windows, doors and exit/entry points for services).
- At the junction between an external cavity wall and every compartment floor and compartment wall.

NVELOPE® CFB

The NVELOPE® CFB range comprises of 4 horizontal open state barriers.

NV CFB 6 →

An open state cavity fire barrier for ventilated cavities up to 450 mm. Utilises an high performance intumescent seal fixed to a high density mineral wool backer. It is mechanically fixed and usually orientated horizontally.



Technical Data

Thickness	Up to 450 mm
Colour	Black
Integrity Fire Rating	Up to 60 minutes
Insulation Fire Rating	Up to 60 minutes

Features & Benefits

- Up to 60 minutes Integrity and Insulation Fire Rating
- Maintains a 25 mm air gap
- Up to 450 mm cavities

NV CFB 12 →

An advanced open state cavity fire barrier for ventilated cavities up to 450 mm. Utilises an high performance intumescent seal fixed to a high density mineral wool backer which offer extended performance over and above CFB 6. It is mechanically fixed and usually orientated horizontally.



Technical Data

Thickness	Up to 450 mm
Colour	Black
Integrity Fire Rating	Up to 120 minutes
Insulation Fire Rating	Up to 90 minutes

Features & Benefits

- Up to 120 minutes Integrity and 90 minutes Insulation Fire Rating
- Maintains a 25 mm air gap
- Up to 450 mm cavities

NV CFB EXTRA →

The superior open state cavity fire barrier for ventilated cavities up to 450 mm which provides additional protection for larger air gaps up to 44 mm. Utilises an high performance intumescent seal fixed to a high density mineral wool backer which offers extended performance over and above CFB 6. It is mechanically fixed and usually orientated horizontally.



Technical Data

Thickness	Up to 450 mm
Colour	Red
Integrity Fire Rating	Up to 60 minutes
Insulation Fire Rating	Up to 60 minutes

Features & Benefits

- Up to 60 minutes Integrity and Insulation Fire Rating
- Maintains a 44 mm air gap
- Up to 450 mm cavities

NV CFB 12/50 →

A ventilated fire barrier that is a rigid, high expansion intumescent strip encased in aluminium foil. It is particularly versatile and can be mechanically fixed both horizontally and vertically within ventilated cavities behind rainscreen or cladding systems to act as a cavity fire barrier. The barrier is simply mechanically fixed in position to leave up to a maximum 44 mm air gap.



Technical Data

Thickness	Up to 50 mm
Colour	Silver
Integrity Fire Rating	Up to 120 minutes
Insulation Fire Rating	Up to 120 minutes

Features & Benefits

- Up to 120 minutes Integrity and Insulation Fire Rating
- Up to 50 mm cavities

NVELOPE® CFB

For closed state vertical or window sealing the NV CFB range describes.

NV CFB UV →

This is a barrier for non ventilated applications and is ideally suited to prevent fire penetration between adjacent vertical compartments within a rainscreen. Manufactured from high density mineral wool to suit a wide range of cavity depths. They are held in place by a combination of compression and multi purpose brackets.



Technical Data

Thickness	Up to 600 mm
Colour	-
Integrity Fire Rating	Up to 120 minutes
Insulation Fire Rating	-

Features & Benefits

- Up to 120 minutes Fire Rating
- Maintenance free
- Unaffected by humidity and moisture
- Up to 600 mm cavities

Barrier Sizes Available

Type	Cavity mm	Product Thickness mm
NV CFB 6	60 (+10 increments up to) 440	35 (+10 increments up to) 415
NV CFB 12		
NV CFB EXTRA		
NV CFB UV	10	80
	20	
	30 (+5 increments up to)	
	95	
	100 (+10 increments up to)	
	600	
NV CFB 12/50	Up to 50	6

To view the relevant fixings for our Cavity Fire Barriers, download our brochure. →

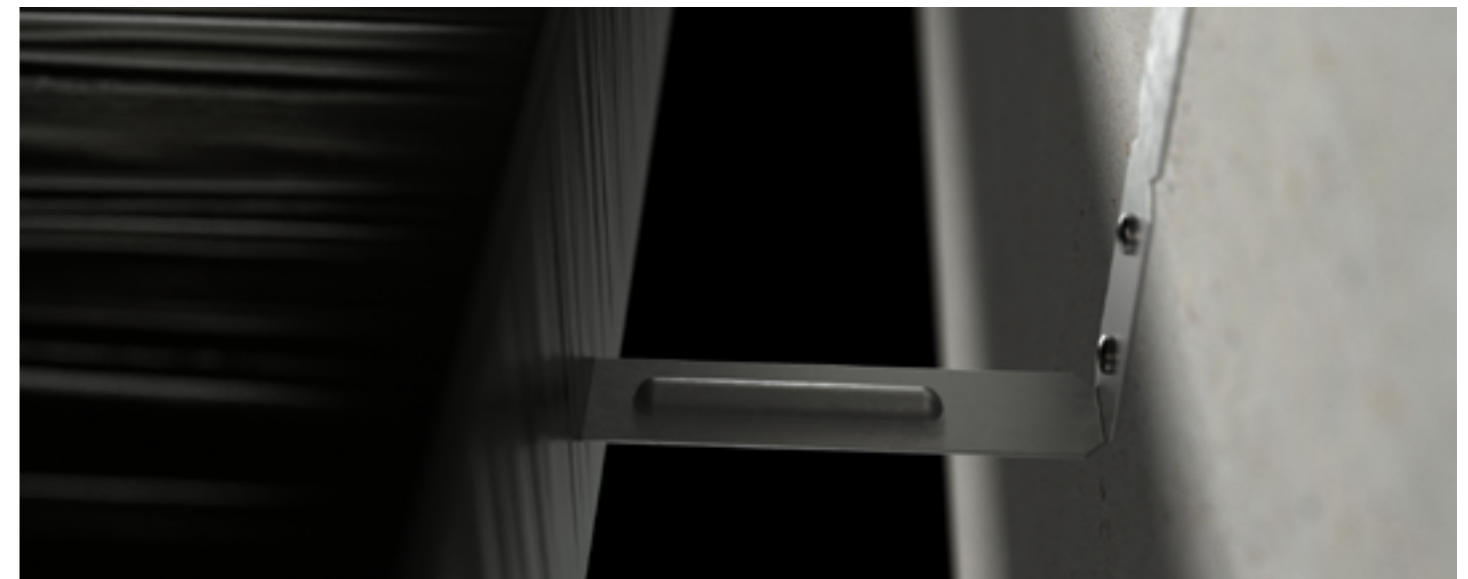

Bracket Options

Aluminium

NVELOPE® aluminium brackets are available in two options.

NVELOPE® VB/HB

NVELOPE® VB/HB aluminium brackets are supplied with a polypropylene "Green Isolator" which offers a degree of thermal benefit. However, its principal function is to eliminate any potential for corrosion between masonry and aluminium substrates.

NVELOPE® VB/HB + Thermal

Whilst strong and easy to install, aluminium is very thermally conductive e.g. $> 200 \text{ W/mK}$. Therefore the thermal point loss affects can be significant when aluminium brackets are utilised depending on the combination of various elements within the rainscreen build-up. The NVELOPE® VB/HB + Thermal range includes an insulation pad at the base of the bracket. This dramatically improves the thermal performance of the rainscreen build-up.

Eurocode 9 (EN 1999-1-1:2007+A1)

The Eurocode series of EN standards relate to the construction industry. Eurocode 9: Design of Aluminium Structures (abbreviated EN 1999 or EC9) describes how to design aluminium structures. It complies with the principles and requirements for the safety and serviceability of building structures and the basis of their design. It further sets the requirements for structural integrity including strength, durability and fire resistance. NVELOPE® aluminium subframe brackets and associated fixings used for rainscreen cladding applications have been designed in accordance with Eurocode

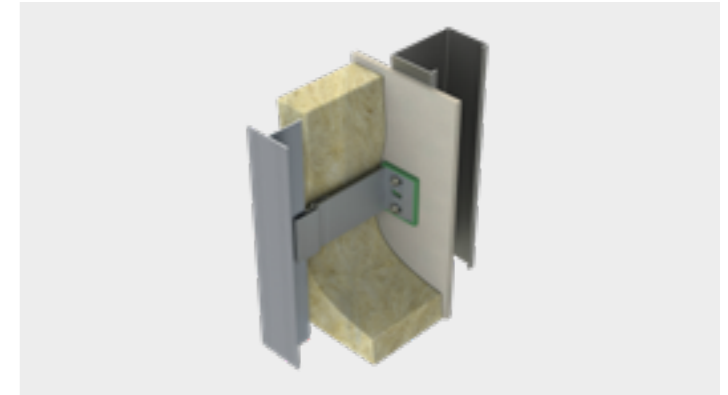

9 and are implemented to the National Annex BS EN 1999 1-5 relevant for the UK.

Eurocode 3 (EN 1993-1-1:2005)

Eurocode 3 applies to the design of buildings, utilising in steel. It complies with the principles and requirements for the safety and serviceability of structures, and the basis of their design. It is concerned with requirements for resistance, durability and fire resistance.

NVELOPE® Stainless steel subframe brackets and associated fixings used for rainscreen cladding applications have been designed in accordance with Eurocode 3 and are implemented to the National Annex BS EN 1993 (informative) relevant for the UK.

NVELOPE® Aluminium Brackets

An extension piece is available for use with 270 mm & 300 mm brackets providing 330 mm & 360 mm respectively.

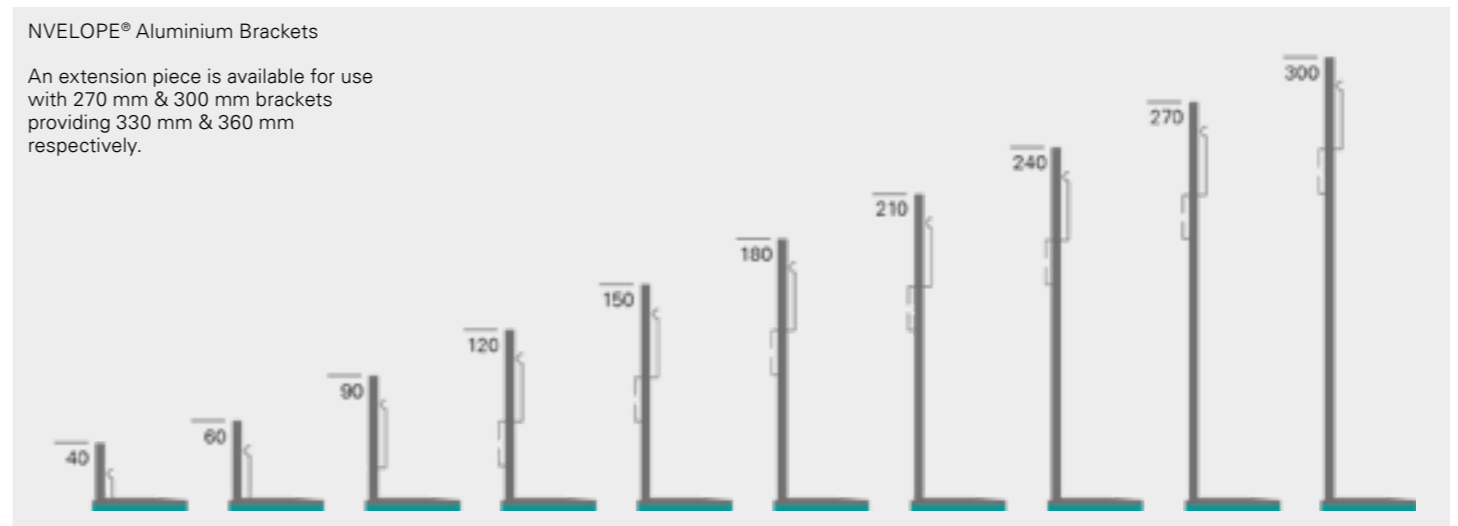

Aluminium Fixed Point & Sliding Point

Profiles (rails) are attached to brackets by a combination of fixed and sliding points to allow for and assure dead load and dynamic load performance. Sliding points are important to accommodate differing thermal effects of materials (dilation) being combined. Dead and dynamic loads as well as dilation effects must be fully accounted for.

The rainscreen façade must be able to “float” on the subconstruction. Each element should have one fixed point. All other fixing points must be executed as sliding points. Fixed point brackets and profiles are connected (Level 2 Fixings) by round holes in the brackets. The fixed point absorbs both vertical weight (deadload) and horizontal wind loads.

Sliding point brackets and profiles are connected (Level 2 Fixings) at the elongated holes (slots) in the brackets. Their primary function is to absorb dynamic horizontal wind loads.

Cementitious Surfaces

All aluminium components in direct contact with cementitious primary substrates, where a risk of corrosion exists, shall be isolated. All NVELOPE® aluminium brackets are isolated via the addition of a polypropylene “Green Isolator” to the foot of the bracket.

This isolator also provides additional thermal insulation which in turn can improve thermal point loss (Chi value) for individual brackets and ultimately, support greater thermal efficiency.

Helping Hands

NVELOPE® vertical brackets come in standard dimensions of 40- 300mm and are available in two sizes, Single and Double. Each bracket has 40mm of adjustment (except the 40mm bracket which has 20mm adjustment). The profiles (rails) are held in place by friction afforded by the ‘helping hands’ feature of the bracket. Once adjusted for line and level they are fixed using the appropriate Level 2 stainless steel fixing.

Aluminium Bracket Options – Suitable for all NVELOPE® systems except NVF2F

Bracket Size mm	min.	max.	Single (6.5/11 mm slot)		Double
			6.5 mm	11 mm	
40	47	67	1582505	1521239	1521238
60	62	102	1582506	1521247	1521246
90	92	132	1582508	1521255	1521254
120	122	162	1582509	1521263	1521262
150	152	192	1582510	1521273	1521271
180	182	222	1582511	1521282	1521281
210	212	252	1582512	1521291	1521290
240	242	282	1582514	1521300	1521299
270	272	312	1582517	1521309	1521308
300	302	342	1582520	1521317	1521316
270 (+extension)*	332	372	1582517 (+1521188)	1521309 (+1521187)	1521308 (+1521187)
300 (+extension)*	362	402	1582520 (+1521188)	1521317 (+1521187)	1521316 (+1521187)

*Example to show largest possible cladding zones. Extension piece is compatible with all bracket sizes, and is available as single (1521188) or double (1521187). Please visit the Accessories → page for more information.

Aluminium Bracket Options NVF2F – suitable for NVELOPE® F2F systems only

Bracket Size mm	min.	max.	Single
72	79	127	1600061
122	125	177	1600062
172	175	227	1600063
222	225	277	1600065
272	275	327	1649538



Aluminium

NVELOPE® NH3 Aluminium bracket size

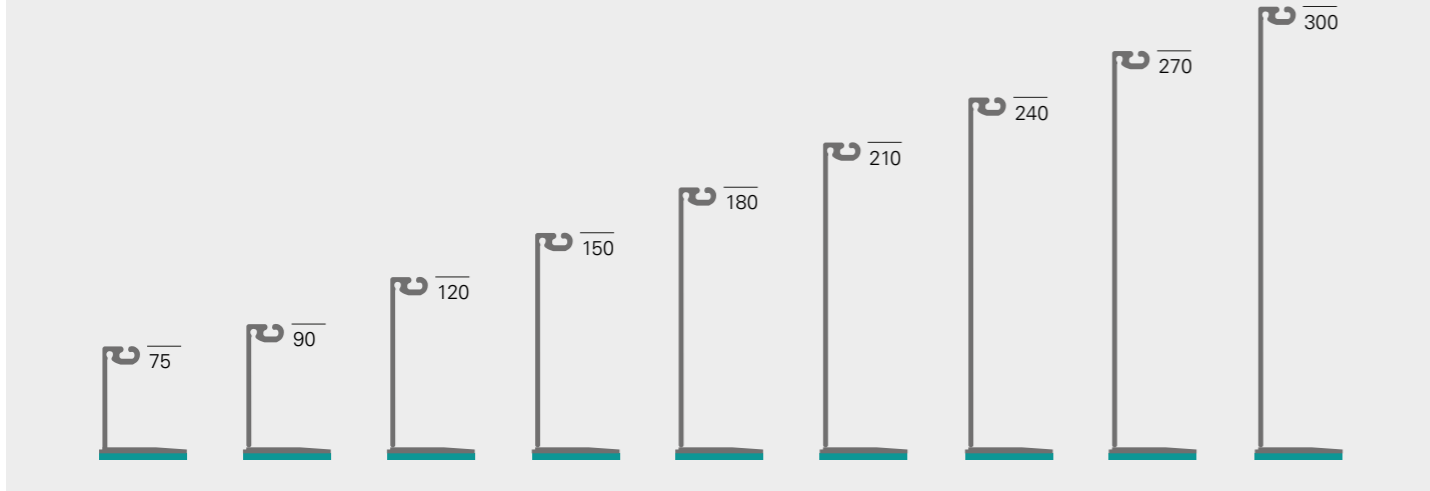

Aluminium Bracket Options – NH3 Suitable for NVELOPE® NH3 systems only

Bracket Size mm	6.5 mm slot	11 mm slot
75	1602052	1602050
90	1602054	1602053
120	1602057	1602056
150	1602059	1602058
180	1062062	1602061
210	1602064	1602063
240	1602066	1602065
270	1602068	1602067
300	1602070	1602069

Profile mm	Size	Product Code
Horizontal Bracket L Profile	60x40x2.5x3'000	1521346
90	60x40x2.5x6'000	1602053



Stainless Steel

NVELOPE® stainless steel brackets are available in two options.

NVELOPE® NVS

For greater thermal performance, SFS have recently introduced a complete range of stainless steel brackets to complement our vertical aluminium ranges. Our stainless steel range is made from superior 316 grade which exhibits greater resistance to localised corrosion in marine environments and in contact with atmospheric pollution found in many built-up environments.

Stainless steel will demonstrate a much improved increase in thermal performance. Typically, stainless steel has a thermal conductivity of 16 W/mK. This represents a 12x thermal improvement over and above aluminium. Additionally, stainless steel brackets have no requirement to utilise an isolator to alleviate corrosion.

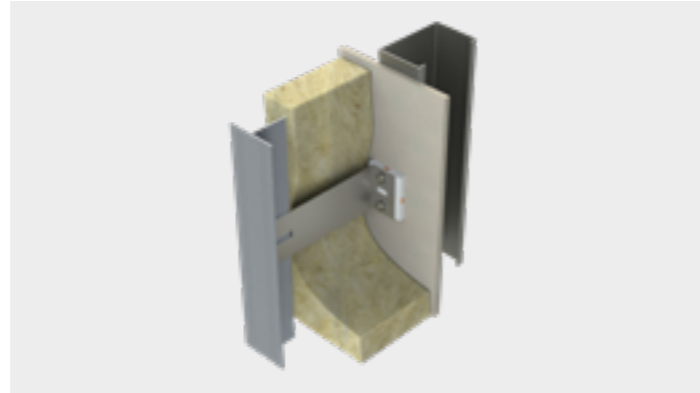

NVELOPE® NVS + Thermal

For **optimum, thermal performance**, NVELOPE® NVS + Thermal is the ideal choice.

It offers the combined benefits of high thermal performance where rainscreen build-up designs prescribe demanding thermal solutions, this option could offer the ideal high performance answer. Our NVELOPE® NVS Stainless Steel bracket combined with our unique Thermal Pad (NVS + Thermal) has been awarded Passive House component accreditation, falling within the Facade Anchor category. The significant reduction in thermal point loss which may be achieved by utilising our NVS + Thermal system is clearly recognised by the Passive House Institute.

Stainless Steel Bracket Options

NVELOPE® Stainless steel bracket sizes

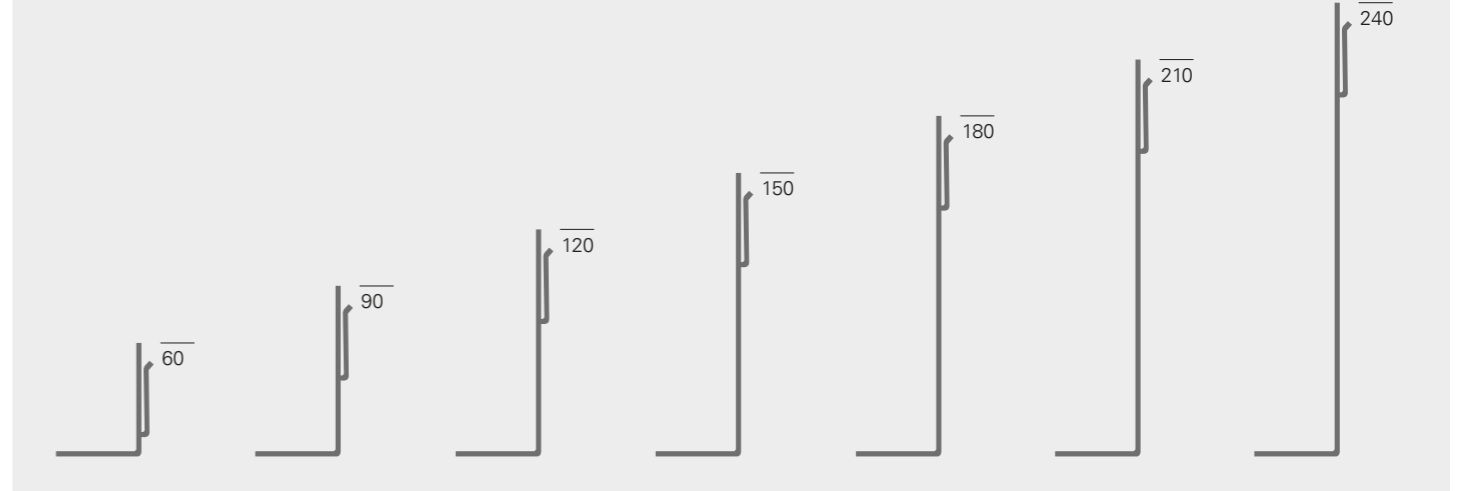

Bracket Size	min.	max.	Single	6.5 mm	Double 11 mm
60	70	105	1667550	1667502	1667508
90	100	135	1667552	1667503	1667509
120	130	165	1667569	1667504	1667510
150	160	195	1667570	1667505	1667545
180	190	225	1667571	1667500	1667546
210	220	255	1667572	1667520	1667548
240	250	285	1667573	1667514	1667549



First Level Fixings

Level 1 Fixing

Fixing Design and Specification considerations: NVELOPE® subframe systems can be used in conjunction with most types of primary wall substrates and includes masonry – brick, concrete, block & stone; lightweight steel framing systems (SFS); Timber frame and Structural Insulated Panels (SIPS). The method of (Level 1) fixation depends on the type of substrate the NVELOPE® system is going to be fixed to.

Further consideration must also be made in regards to the design loading capabilities of the level 1 fixings as defined by Technical Performance Values within European Technical Approval (ETA) standards or determined via On-Site “Pull-Out” strength testing. Windload evaluation and calculations derived from our Project Builder digital tool can be utilised to accurately predict the density and vertical and horizontal centres of our NVELOPE® subframe supporting brackets for any particular project.

Level 1 Fixings For Concrete, Brick & Block

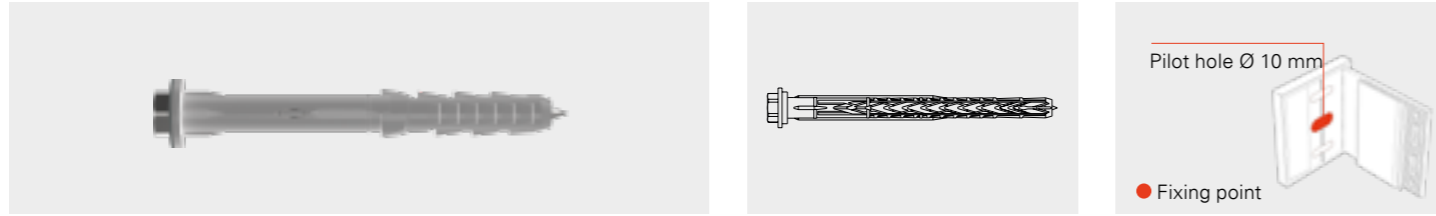

SXR-10x60-FUS-A4

Min. Embedment	50 mm
Clamping Length t_{fix}	10 mm
Head style S	13 mm Hex, T40 drive
Material	316 Stainless Steel A4
Product code	1333579
Systems supported	NV1-NV10, NH3

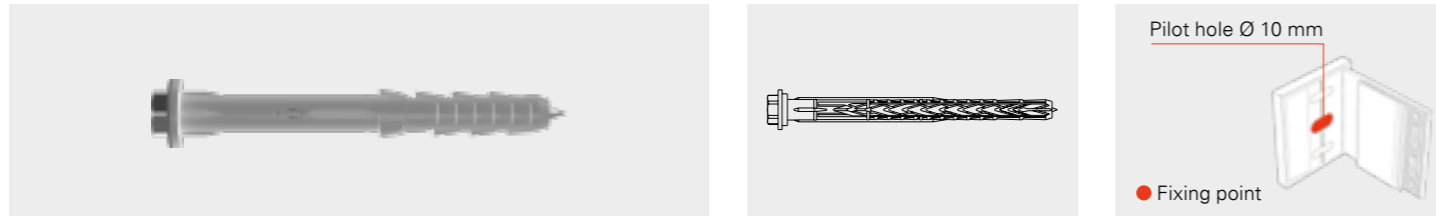

SXR-10x80-FUS-A4

Min. Embedment	50 mm/70 mm
Clamping Length t_{fix}	10 mm/30 mm
Head style S	13 mm Hex, T40 drive
Material	316 Stainless Steel A4
Product code	1551174
Systems supported	NV1-NV10, NH3

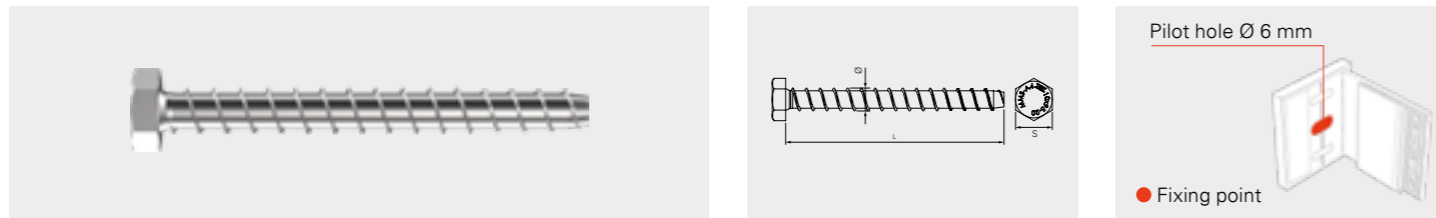

MMS-S-7,5x75-A4

Min. Embedment	65 mm
Clamping Length t_{fix}	10 mm
Head style S	13 mm Hex
Material	316 Stainless Steel A4
Product code	1479976
Systems supported	NV1-NV10, NH3, NS1

Level 1 Fixings For Concrete, Brick & Block

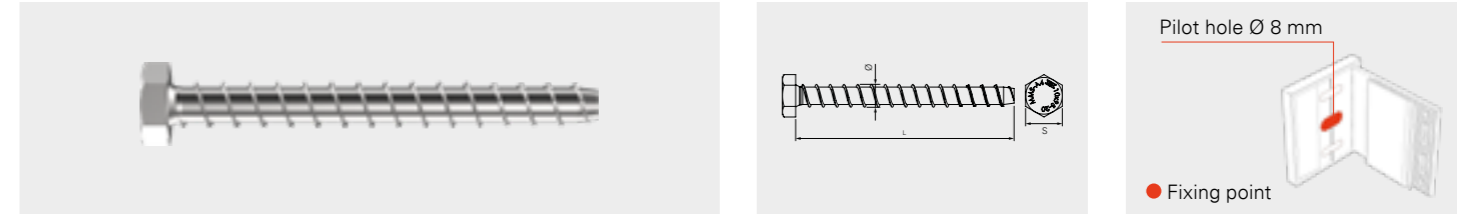

MMS-S-10x85-A4

Min. Embedment	75 mm
Clamping Length t_{fix}	10 mm
Head style S	16 mm Hex
Material	316 Stainless Steel A4
Product code	1480024
Systems supported	All

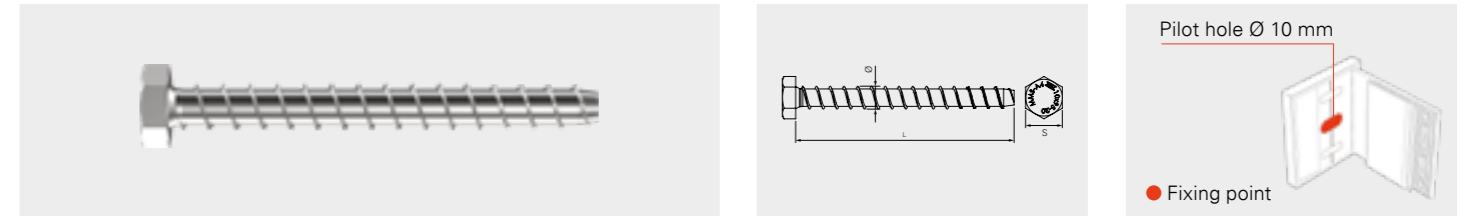

MMS-S-12x100-A4

Min. Embedment	90 mm
Clamping Length t_{fix}	10 mm
Head style S	18 mm Hex
Material	316 Stainless Steel A4
Product code	1480026
Systems supported	F2F

Level 1 Fixings For Steel & Timber

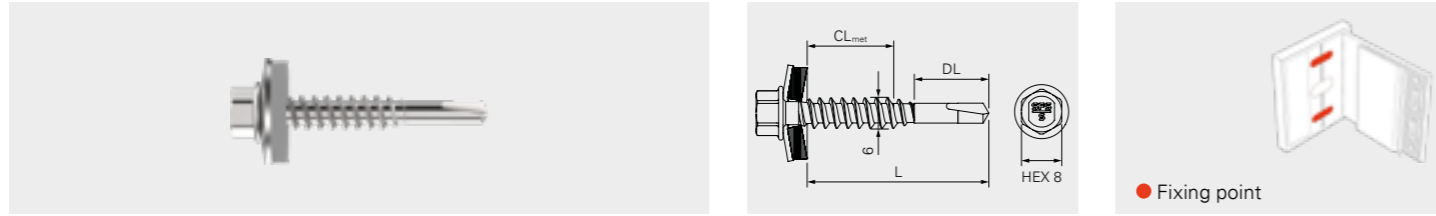

SX3-S16-6x29-A2

Min. Steel Thickness	0.63 mm
Min. Aluminium Thickness	1.0 mm
Clamping Length t _{fix}	9 mm
Material	304 Stainless Steel A2
Product code	1141978
Systems supported	NV9,NS1

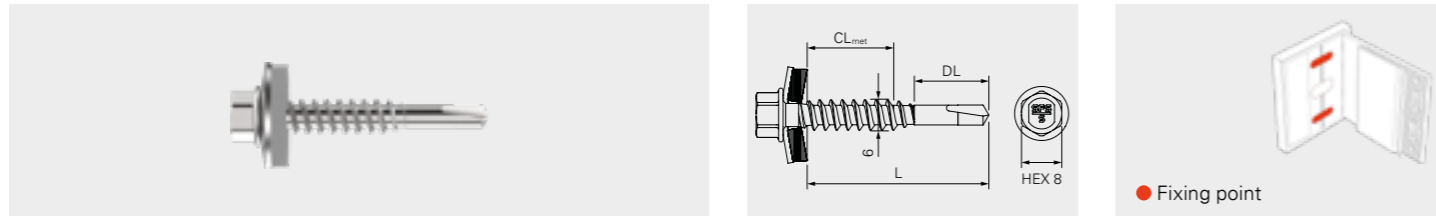

SX3-S16/A4-6x48-A4

Min. Steel Thickness	0.63 mm
Min. Aluminium Thickness	1.0 mm
Clamping Length t _{fix}	28 mm
Material	316 Stainless Steel A4
Product code	1575777
Systems supported	NV1–NV10,NH3,NS1

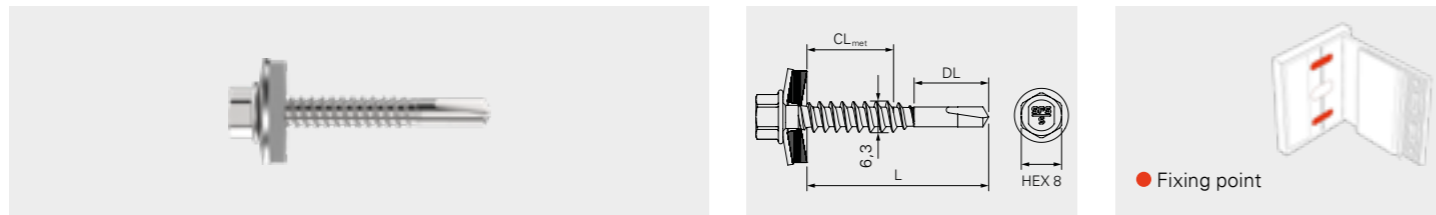

SX5/36-S16/A4-6,3x55-A4

Min. Steel Thickness	1.50 mm
Clamping Length t _{fix}	36 mm
Material	316 Stainless Steel A4
Product code	1570614
Systems supported	NV1–NV10,NH3,NS1

Level 1 Fixings For Steel & Timber

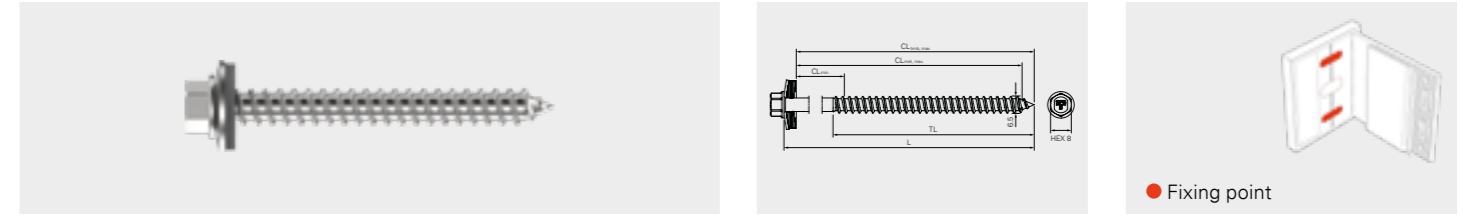

TDA-S-S16-6,5x60

Min. Steel Thickness	0.63 mm
Min. Aluminium Thickness	1.0 mm
Clamping Length t _{fix}	50 mm
Min. Embedment Wood	35 mm
Material	316 Stainless Steel A4
Product code	1526326
Systems supported	NV1–NV10,NH3,NS1

TDA-S-S16-6,5x60 - Pre-drill diameter

Application	Steel/Steel and Alu/Steel			Steel/Timber	Alu/Alu			
	Component 1 (t ₁)	0.5–1.50			0.5–1.50	0.5–1.50		
Component 2 (t ₂)	0.63	0.75	0.88–1.25	1.50–3.0	≥35.0	1.0–1.50	2.0–2.50	3.0
		2×0.75–2×1.0	2×1.25–2×1.5					
	S280GD – S450GD (EN10346) HX300LAD to HX460LAD (EN10346)			Timber (EN14081)	Aluminium (EN573)			
Pre-drill Ø	3.50	4.0	4.50	5.0	4.0	4.50	5.0	5.30



Profiles (Rails)

SFS manufacture and supply a wide range of aluminium profiles (rails) engineered for specific use with our NVELOPE® aluminium or stainless steel bracket systems.

Profiles (rails) are used in combination with all our bracket variations. The length of profiles used in vertical applications is dependent on the building storey height. Due to expansion dilation effects, the relationship between the cladding material and sub-frame support system must be considered.

The designer will consider the structural design or preliminary survey of the sub structure, to prepare a layout or grid for the positioning of the subframe (brackets and profiles).

SFS have identified a market need to move more activities “off-site” and we recognise the benefits that this brings. Our profile cutting service optimises material usage, reduces waste and lowers costs. Find out more here.

Profile overview

Name	Profile Size mm	Compatible Systems	Grade	Available Lengths m	Available Finishes	Thickness mm
L Profile	60x40	NV1, NV2, NV3, NV4, NV5, NV8, NV10, NH3, NS1	6005A T6	3.0, 3.60, 4.85, 6.0	PC, An, MF	2.20

Key Features: Supports the face fix of intermediate panel spans and edges. Provides a permanent framework for many other NVELOPE® system profiles.

T Profile	60x80	NV1, NV2	6005A T6	3.0, 6.0	PC, An, MF	2.20
	60x100			3.0, 3.60, 4.85, 6.0		
	40x100			3.0, 6.0		
	60x120					
	60x140					

Key Features: Supports face fix at the vertical joints between two adjacent panels.

Lipped L Profile	60x40x12.5	NH3	6005A T6	3.0, 6.0	PC, An, MF	2.50
Omega	25x120, 40x140	NV1, NV9, NH3, F2F	6063 T6			2.40

Key Features: Provides the vertical framework that makes up NV9. Utilised horizontally, fixed to NV1 to receive faced fixed panels.

Zed	25x45x30	NV1, NV9, NH3, F2F	6063 T6	3.0, 6.0	PC, An, MF	2.40
	40x55x30					

Key Features: Provides the vertical framework that makes up NV9. Utilised horizontally, fixed to NV1 to receive faced fixed panels.

Corner Profile	60x60	NV1	6005A T6	3.0, 6.0	PC, An, MF	2.20
NV3 Profile	60x21	NV3, NV9, F2F				2-30
NV4 Profile	60x32	NV4, NV9, F2F	6063 T66, 6005A T6			
NV5 Profile	Start Rail 36x54, Main Rail 36x65	NV5, NV9, F2F	6005 T6		PC, An	2.0
NV7 Profile	85x90	NV7	6063 T6	3.0	PC, An, MF	2.20-2.70
NV8 Profile	24x86	NV8, F2F	6005A T6	3.0, 6.0		2.0
NV10 Profile	52x21	NV10		3.0		
F2F Box	75x46	F2F		3.0, 6.0		3.0
F2F T Box	75x125					
Steel Top Hat	150x25	NV1, NV2, NV3, NV4, NV5, NV6, NV7, NV8, NV10	S280 GvS	3.0	GvS	2.0

PC – Powder Coated An – Anodised MF – Mill Finish GvS – Galvanised Steel

L Profile 60x40

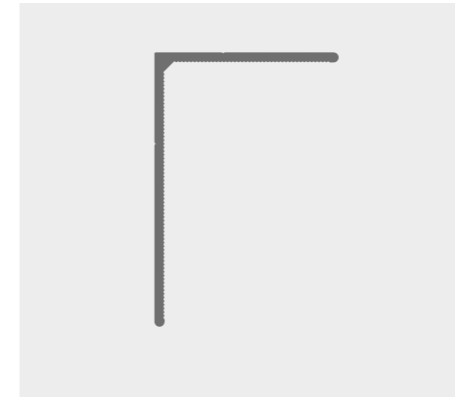

T Profile 60x80

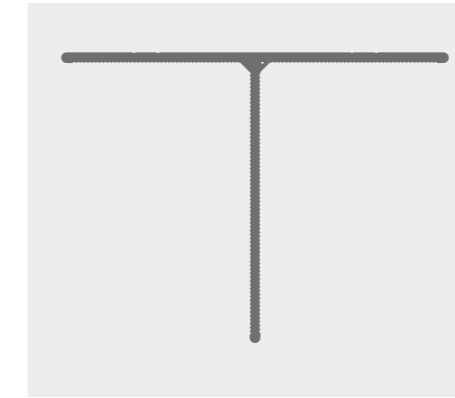

T Profile 60x100

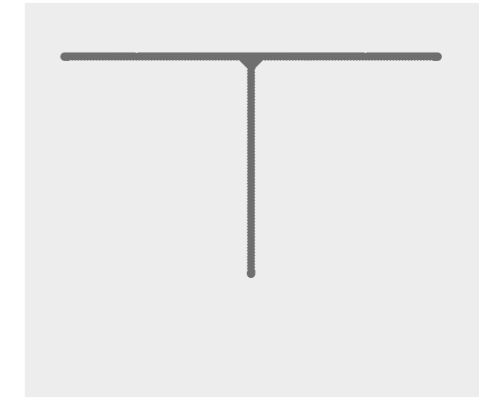

T Profile 40x100

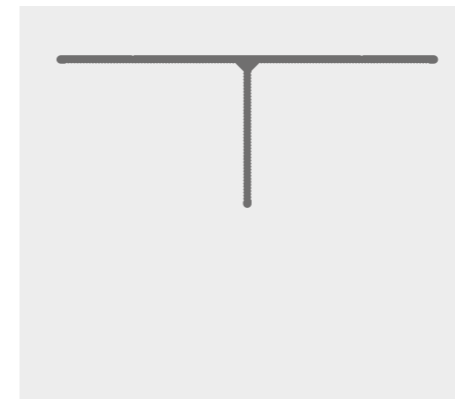

T Profile 60x120

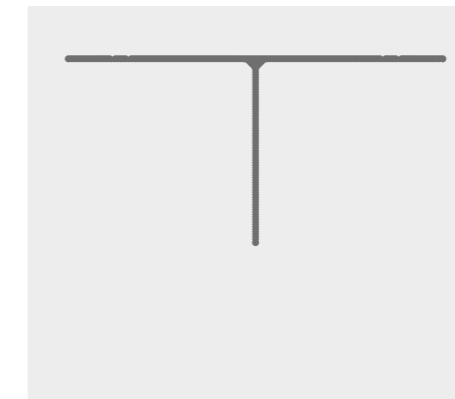

T Profile 60x140

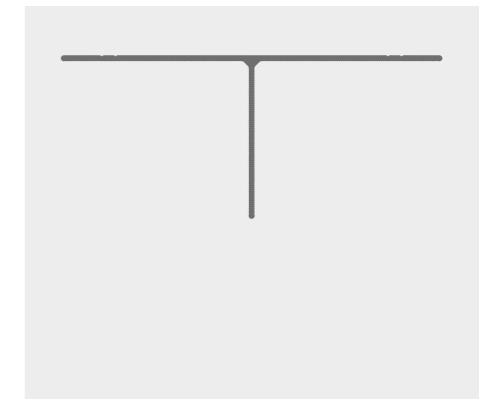

Lipped L Profile

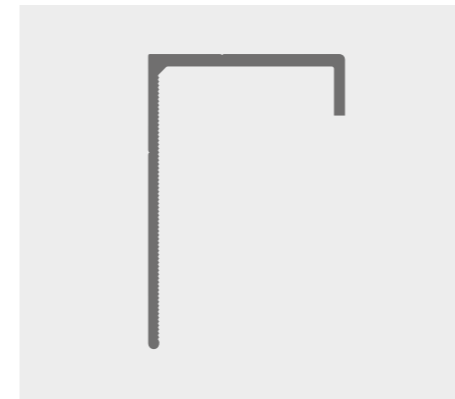

Omega 25x120

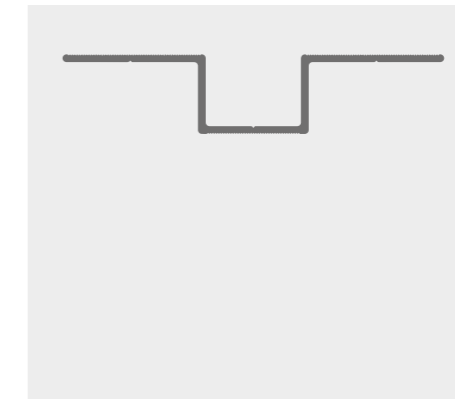

Omega 40x140

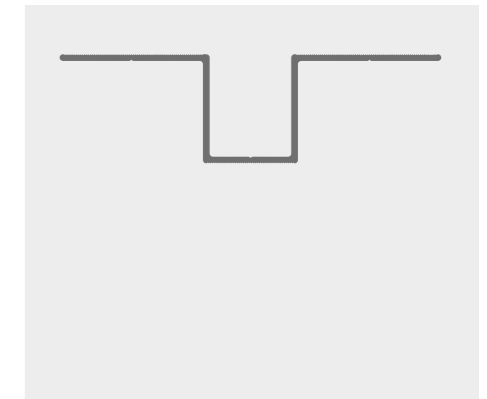

Zed 25x45x30

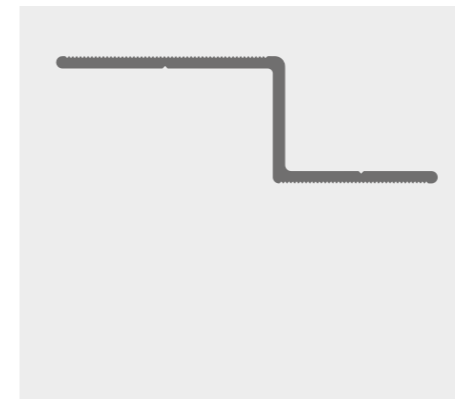

Zed 40x55x30

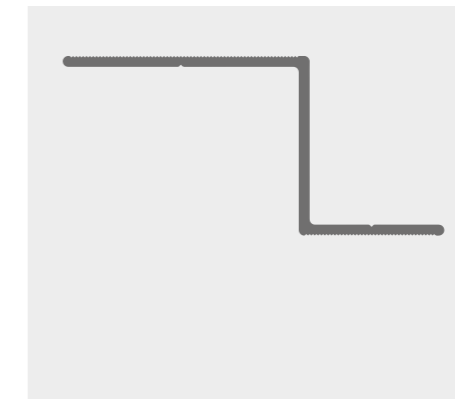

Corner Profile

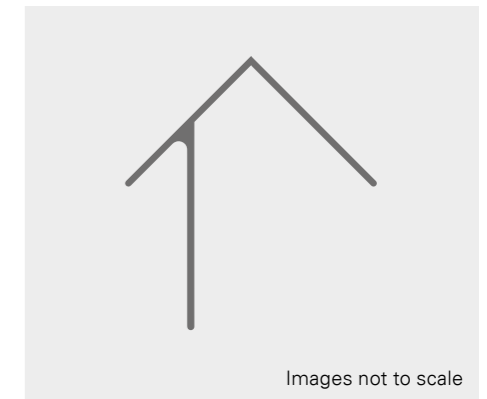

Images not to scale

NV3 Profile

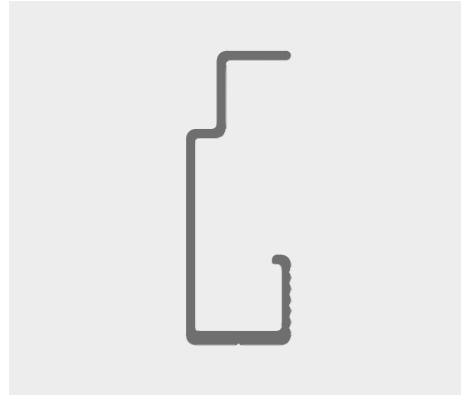

NV4 Profile

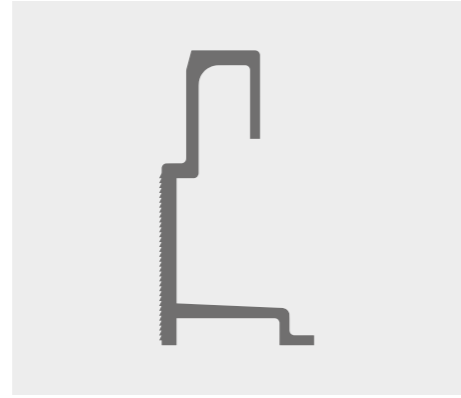

NV5 Profile – Main

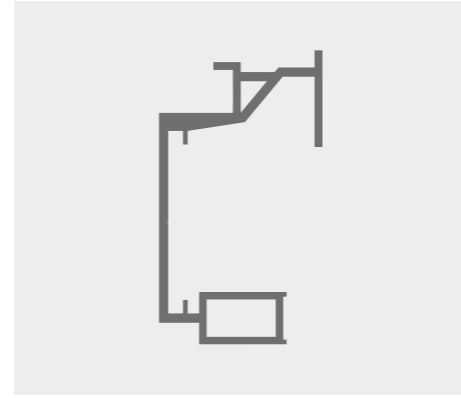

NV5 Profile – Starter

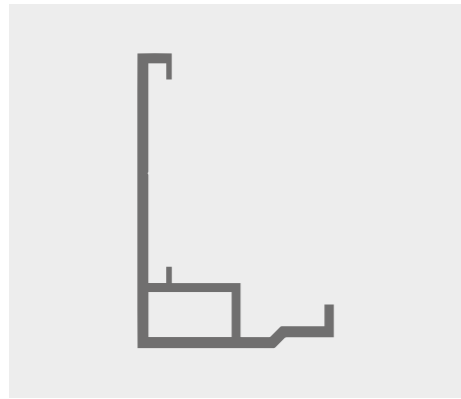

NV7 Profile

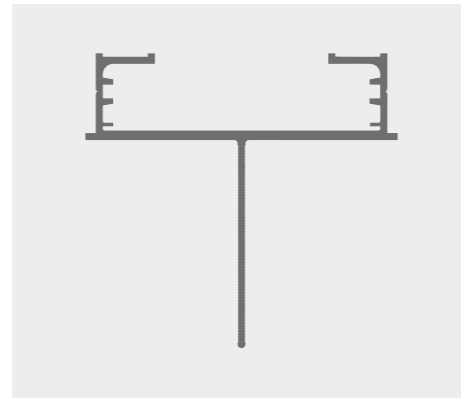

NV8 Profile

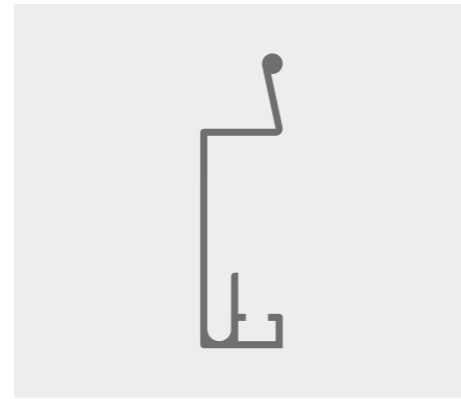

NV10 Profile

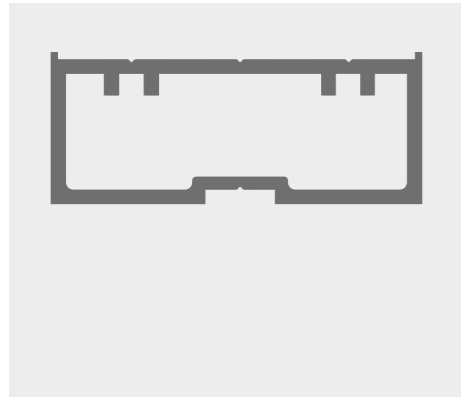

F2F Box

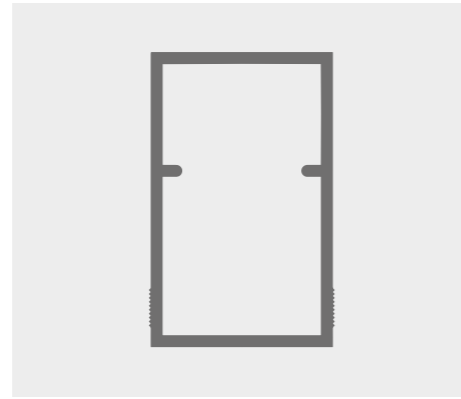

F2FT Box

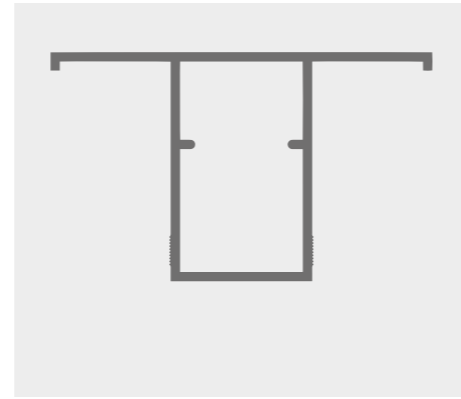

Steel Top Hat

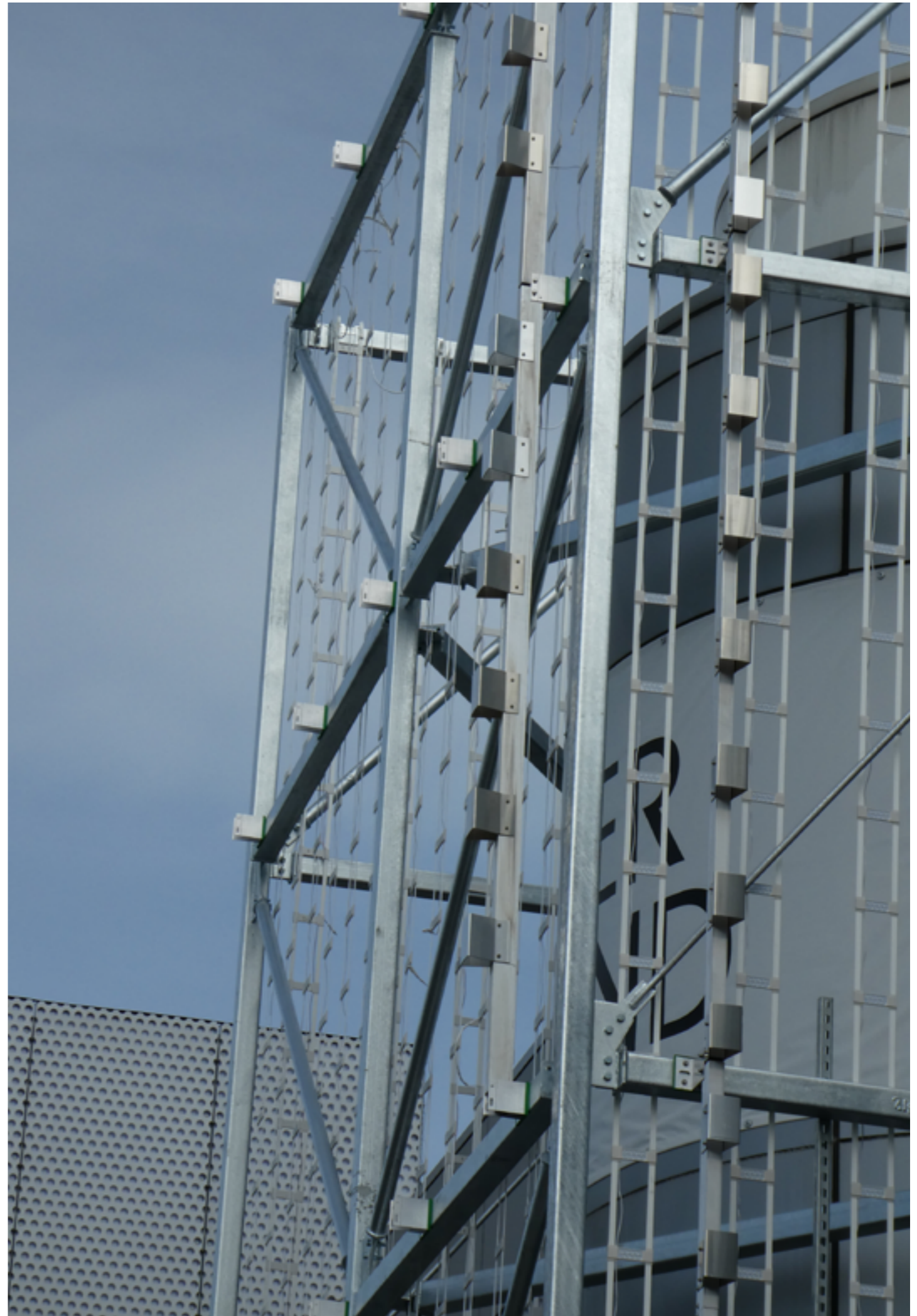
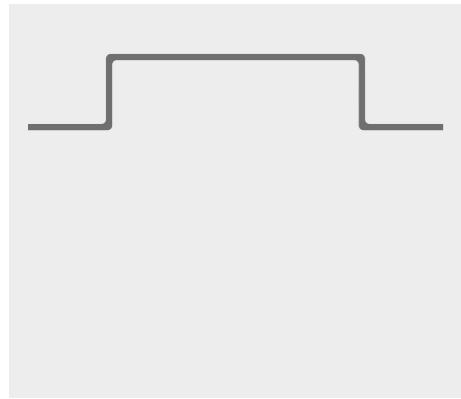



Second Level Fixings

Level 2 Fixings For Bracket & Rail Fixings

Fixing Design and Specification considerations: SFS Level 2 fixings are support structure fasteners used to fasten our NVELOPE® profiles (rails) to the various bracket combinations.

Our SFS fixings used for level 2 subframe applications assure:

- Long-term performance. All our fixings are available in corrosion resistant stainless steel and available as A4 (AISI 316)
- High shear loads offering greater security
- Permanent fixation. Our SDA5 fixings feature a “unique thread geometry” which allows overwinding during installation and at the same time prevents unwinding once installed

Level 2 Fixings For Bracket & Rail Fixings

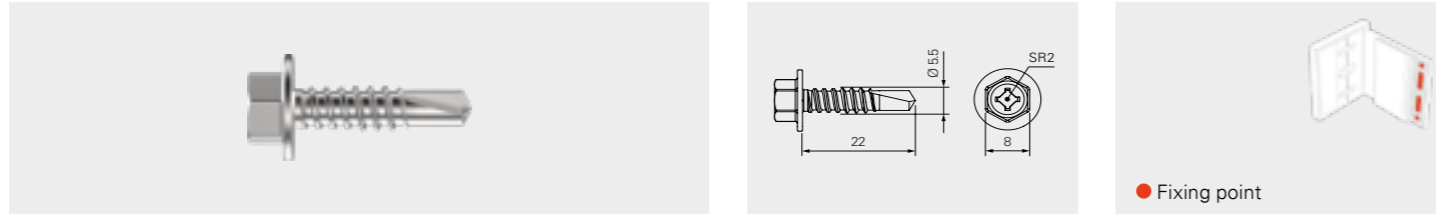

SDA5/3,5-8-H13-S4-5,5x22

Min. Aluminium Thickness	1.50 mm
Clamping Length t_{fix}	3.50–8.0 mm
Head style S	8 mm Hex, No. 2 square drive
Material	316 Stainless Steel A4
Product code	1507572
Systems supported	NV1–NV8, NV10

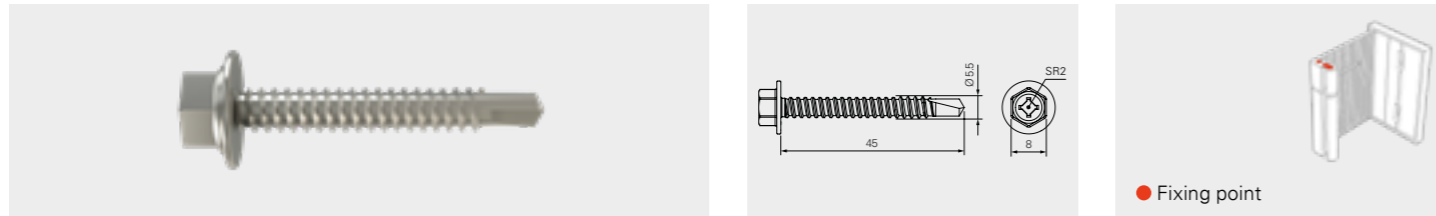

SDA5/25-28-H13-S4-5,5x45

Min. Aluminium Thickness	1.50 mm
Clamping Length t_{fix}	25–28 mm
Head style S	8 mm Hex, No. 2 square drive
Material	316 Stainless Steel A4
Product code	1645134
Systems supported	NH3

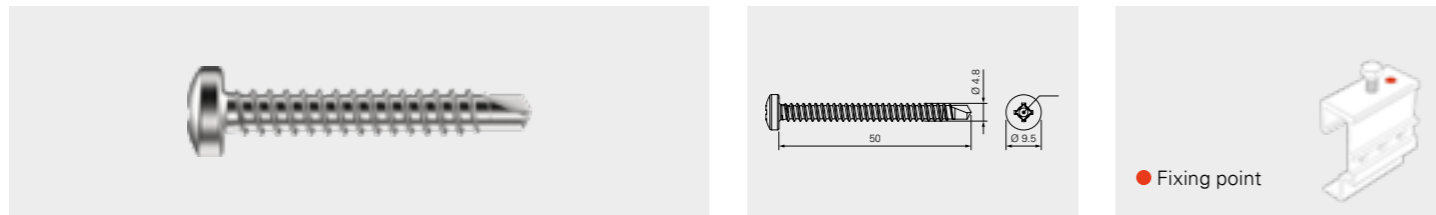

SN3/42-S-7049/SR2-4,8x50-A4

Clamping Length t_{fix}	42 mm
Head style S	No. 2 square drive
Material	316 Stainless Steel A4
Product code	1508066
Systems supported	NV3, NV4, NV8, NV10

Level 2 Fixings For Bracket & Rail Fixings

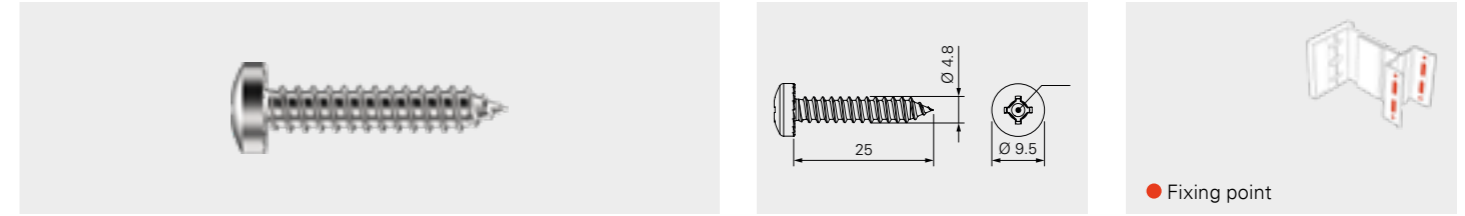

VAT-S-7049/SR2-4,8x25

Clamping Length t_{fix}	20 mm
Head style S	No. 2 square drive
Material	304 Stainless Steel A2
Product code	848571
Systems supported	NV6



M8 Bolt Kit

Length	70mm
Head style S	13 mm Hex
Material	316 Stainless Steel A4 & 316 Stainless Steel Washer & Nylon Washer
Product code	1600079
Systems supported	F2F



Third Level Fixings

Level 3 Fixings TUF-S – Secret Fix

The TUF-S blind fastener from SFS is superior to previous approaches to the attachment of HPL or fibre cement cladding panels with regards to installation and long-term security.

Installation is performed quickly and securely by one person, without the use of special tools. Installation time is also reduced by up to 50% when compared to conventional blind attachments. The TUF-S blind fastener can be removed once if required.



Panel Thickness	Hanger	Drill depth	TUF-S	Product code	Drill bit
8.0	2.0	5.0	TUF-S-6x7-A4	1554316	VHM-6,0x40
		5.50	TUF-S-6x7,5-A4	1554377	VHM-6,0x40,5
		6.0	TUF-S-6x8-A4	1554321	VHM-6,0x41
	2.50	5.0	TUF-S-6-7,5-A4	1554377	VHM-6,0x40
		5.50	TUF-S-6x8-A4	1554321	VHM-6,0x40,5
		6.0	TUF-S-6x8,5-A4	1554378	VHM-6,0x41
	3.0	5.0	TUF-S-6x8-A4	1554321	VHM-6,0x40
		5.50	TUF-S-6x8,5-A4	1554378	VHM-6,0x40,5
	3.50	5.0	TUF-S-6x8,5-A4	1554378	VHM-6,0x40
		5.50	TUF-S-6x9-A4	1554325	VHM-6,0x40,5
5.0	5.0	TUF-S-6x10-A4	1554326	VHM-6,0x40	
	6.0	TUF-S-6x11-A4	1554327	VHM-6,0x41	
	6.0	TUF-S-6x11-A4	1554327	VHM-6,0x41	
10.0	3.0	6.0	TUF-S-6x9-A4	1554325	VHM-6,0x41
		7.0	TUF-S-6x10-A4	1554326	VHM-6,0x42
		8.0	TUF-S-6x11-A4	1554327	VHM-6,0x43
	3.50	6.50	TUF-S-6x10-A4	1554326	VHM-6,0x41,5
		7.50	TUF-S-6x11-A4	1554327	VHM-6,0x42,5
	5.0	7.0	TUF-S-6x12-A4	1554328	VHM-6,0x42
		8.0	TUF-S-6x13-A4	1554329	VHM-6,0x43
12.0	3.50	8.50	TUF-S-6x12-A4	1554328	VHM-6,0x43,5

Use the drill bits with the SFS depth locator universal

Depth locator universal
with Ø 6 mm VHM drill bit



GESIPA® battery
riveting tool



Drill



Level 3 Fixings AP Rivets – Face Fix

The SFS AP rivets are ideal for securing high performance cladding panels to aluminium support systems. Their superior quality and performance makes them an ideal choice, colour matched to leading OEM's panels and despatched within three days from ordering.

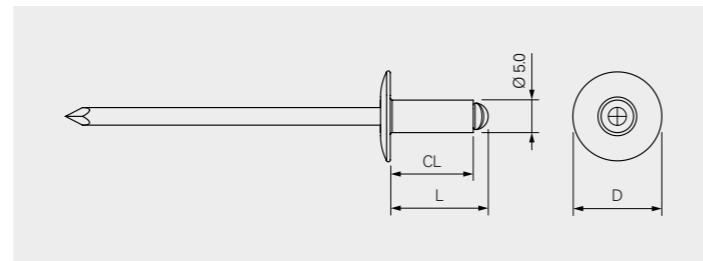

Diameter	Length L	Flange D	CL/Grip range	Drill hole Ø
5.0	12	11	4.0–8.0	5.1
	18		9.50–13.50	
	21		10.0–16.0	
	12	14	4.0–8.0	
	16		8.0–12.0	
	18		9.50–13.50	
	21		12.0–16.0	
	23	14.0–18.0		
	16	16	8.0–12.0	
	18		9.50–13.50	
	21		12.50–16.50	

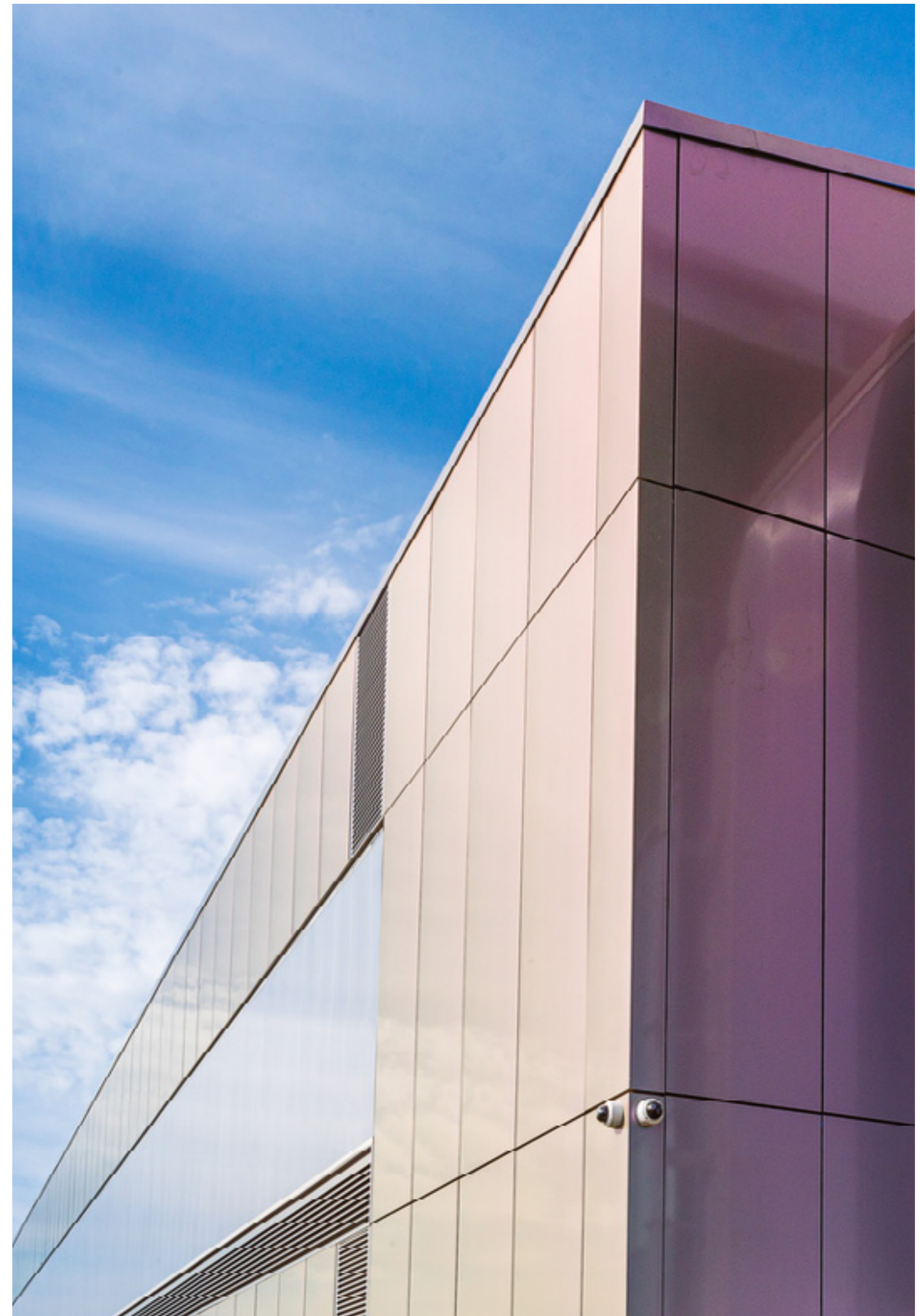



NV3 – Hanger Options

NV3 is the NVELOPE® subframe system suitable for concealed fix/mechanically secret fixed applications. The NVELOPE® NV3 system is compatible with high-pressure laminate (HPL), ceramic and thin stone including fibre cement. Horizontal NVELOPE® carrier profiles are fixed to the vertical profiles. Rainscreen panels are hung from and secured with hangers.

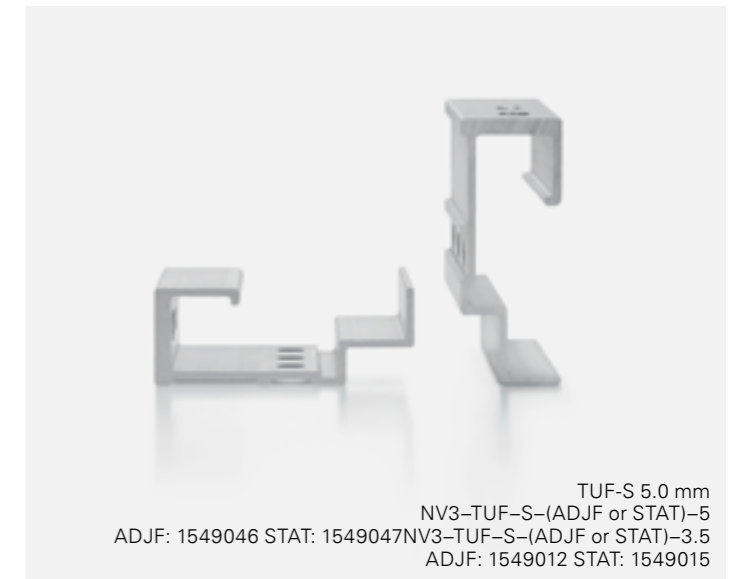
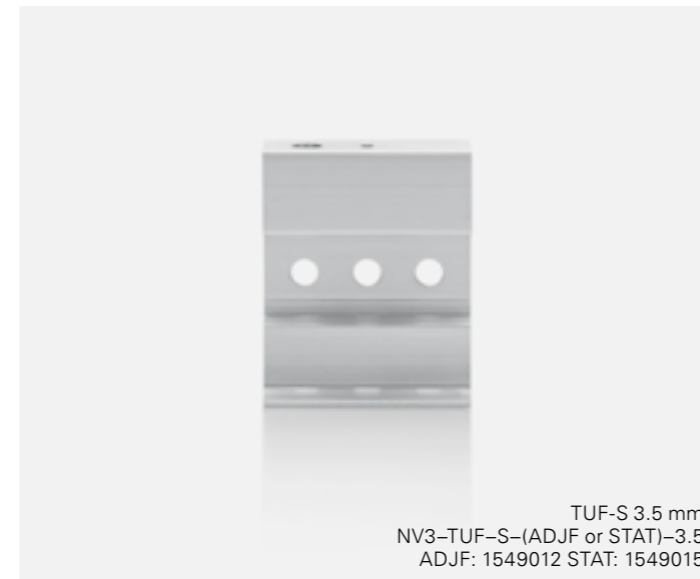

Additional Hangers Available

Name	Product Code	ADJF	STAT
PTS	NV3-PTS-(ADJF or STAT)	1521457	1521459
Keil	NV3-KEIL-(ADJF or STAT)	1521454	1521456
Keil 150 mm	NV3-KEIL-ADJF-150	1521455	-
Tergo	NV3-TER-(ADJF or STAT)	1521465	1521468
Tergo Plus	NV3-TER-TEC-(ADJF or STAT)	1521469	1521470



Accessories

NVELOPE® have a range of accessories which can be used in conjunction with many of our subframe systems. They include adaptors, extenders, connectors, corner brackets and corner rails and a useful rail cover. Whilst these component probably won't be needed for many projects they can offer a useful remedy to a particular design requirement.

Item	Description	Supported Systems	Product Code
Adaptor Washers	Available in sizes 11 mm to 6.50 mm and 11 mm to 8.50 mm.	NV1-NV8, NV10, NVF2F, NH3, NS1	1623696
Bracket Extender	Single and Double sizes. Will extend any bracket by 60 mm.	NV1-NV8, NV10	1521187 1521188
Rail Connector	This can be used on any rail to join two pieces together.	NV1-NV5, NV8, NV10	1521190
NV3 Rail Cover	This can be used to cover NV3 rail at open panel joints. This saves powder coating the complete rail length.	NV3, NV4, NV10	1623696
Corner Bracket	Undrilled, single and double corner bracket.	NV1, NV2, NV6	1521185 1521186
Corner Rail	For use with the corner bracket.	NV1, NV2	1607594 1607596



SFS Group Fastening Technology Ltd.
Division Construction
153 Kirkstall Road
Leeds, LS4 2AT
ukenquiries@sfs.com
www.uk.sfs.com

All information is non-binding and without guarantee. Before using the products, all specifications and calculations must be checked by a suitably qualified person and local regulations must be observed. This document is subject to revision. We reserve the right to make technical changes.
V1.01 01/2022.